



Upgrading OmniSwitch 7700/7800/8800 to 5.1.6.R02

Overview

This instruction sheet documents how to upgrade OmniSwitch 7700 CMM (OS7700-CMM), OmniSwitch 7800 CMM (OS7800-CMM), and OmniSwitch 8800 CMM (OS8800-CMM) modules to 5.1.6.R02 software and firmware. These upgrade (all types) can be done locally or remotely, without physically accessing the chassis.

WARNING. Failure to follow the steps correctly can permanently damage CMM hardware.

This instruction sheet only applies to users upgrading to 5.1.6.R02. Do not use this instruction sheet for upgrades on later builds.

CAUTION. If you want to downgrade from 5.1.6.R02 on a switch with dual CMMs, the downgrade *must* be done individually on the CMMs. There is no problem on a single CMM chassis.

Upgrade Steps

This instruction sheet requires that the following conditions exist or are performed before upgrading:

Perform the following steps:

- 1 Use WebView (see [Verifying the Upgrade with WebView on page 26](#)) or use the **show hardware info** and the **show microcode** commands (see [Verifying the Upgrade with the CLI on page 37](#)) to verify that the MiniBoot/BootROM version is 5.4.1.455.R01, the FPGA version is 44, and the software version is 5.1.6.R02. If so, do *not* perform these instructions. If not, continue to the next step.
- 2 If the software version is not 5.1.6.R02 perform the steps described in [Upgrading the Image Files with WebView on page 4](#) or [Upgrading the Image Files with the CLI on page 28](#).
- 3 If the MiniBoot/BootROM version is not 5.4.1.455.R01 perform the steps the steps described in [Updating the MiniBoot/BootROM with WebView on page 8](#) or [Updating the MiniBoot/BootROM with the CLI on page 30](#).
- 4 If the FPGA version is not 44 perform the steps described in [Upgrading OmniSwitch 7700/7800 FPGA with WebView on page 13](#), or [Upgrading OmniSwitch 8800 FPGA with WebView on page 18](#), [Upgrading OmniSwitch 7700/7800 FPGA with the CLI on page 32](#), or [Upgrading OmniSwitch 8800 FPGA with the CLI on page 34](#)

CAUTION. By default, a shunt connecting pins 1 and 2 on jumper block J31 (OS7700-CMM), jumper J345 (OS7800-CMM), or jumper J21 (OS8800-CMM) is installed on all CMMs. (This jumper connection allows firmware upgrades on CMMs.) If this shunt has been removed and you need to upgrade your CMM's firmware, perform the steps in [Program Enable Jumpers Not Installed on page 38](#) in the [Troubleshooting](#) section before proceeding.

Prerequisites

This instruction sheet requires that the following conditions exist or are performed before upgrading:

- All CLI commands must be executed via a Console Port connection, not through a Telnet session. If you are performing a remote upgrade, then the console port must be connected through a terminal server (via Telnet, PuTTY, etc.) in the same location as the switch you are upgrading.
- Alcatel recommends that you have at least 4.2 MB of free space in **/flash** memory on OmniSwitch 7700/7800 and 8800 switches before beginning.
- If all of the update files (**miniboot.default**, **miniboot.backup**, **bootrom.bin**, and either **Ffpga.upgrade_kit** or **Efpga.upgrade_kit**) are to be downloaded to flash at the same time, then there should be 6 megabytes of flash free prior to the load and subsequent update.
- The person performing the upgrade must:
 - be the responsible party for maintaining the switches' configuration
 - be aware of any issues that may arise from a network outage caused by improperly loading this code
 - understand that the switch must be rebooted and network users will be affected by this procedure
 - have a working knowledge of the switch to configure it to accept an FTP connection through the EMP or Network Interface (NI) Ethernet port.

WARNING. Do not proceed until all the above prerequisites have been met.

List of Topics

See below for a list of topics in this instruction sheet.

Upgrading the Image Files with WebView	4
Updating the MiniBoot/BootROM with WebView	8
Upgrading OmniSwitch 7700/7800 FPGA with WebView	13
Upgrading OmniSwitch 8800 FPGA with WebView	18
Verifying the Upgrade with WebView	26
Verifying the Firmware with WebView	26
Verifying the Software with WebView	27
Upgrading the Image Files with the CLI	28
Updating the MiniBoot/BootROM with the CLI	30
Upgrading OmniSwitch 7700/7800 FPGA with the CLI	32
Upgrading OmniSwitch 8800 FPGA with the CLI	34
Verifying the Upgrade with the CLI	37
Troubleshooting	38
Program Enable Jumpers Not Installed	38

Upgrading the Image Files with WebView

Follow the steps below to upgrade the image files on OmniSwitch 7700/7800/8800 switches to Release 5.1.6.R02 with WebView. You should review all steps in this procedure before beginning.

Caution. Do not FTP the **miniboot.default**, **miniboot.backup**, **bootrom.bin**, and FPGA files at this time. See the related sections for those instructions.

Recommendation. release 5.1.6.R02 configuration files are *not* backwards compatible to Release 5.1.5 and earlier. Therefore, Alcatel recommends that you back up your configuration files before beginning.

- 1 FTP the 5.1.6.R02 image files to the **/flash/working** directory.

Note. If you have dual CMMs make sure you FTP the files to the primary CMM.

- 2 Log into WebView.
- 3 Select **System > System Mgmt > Install** as shown below:

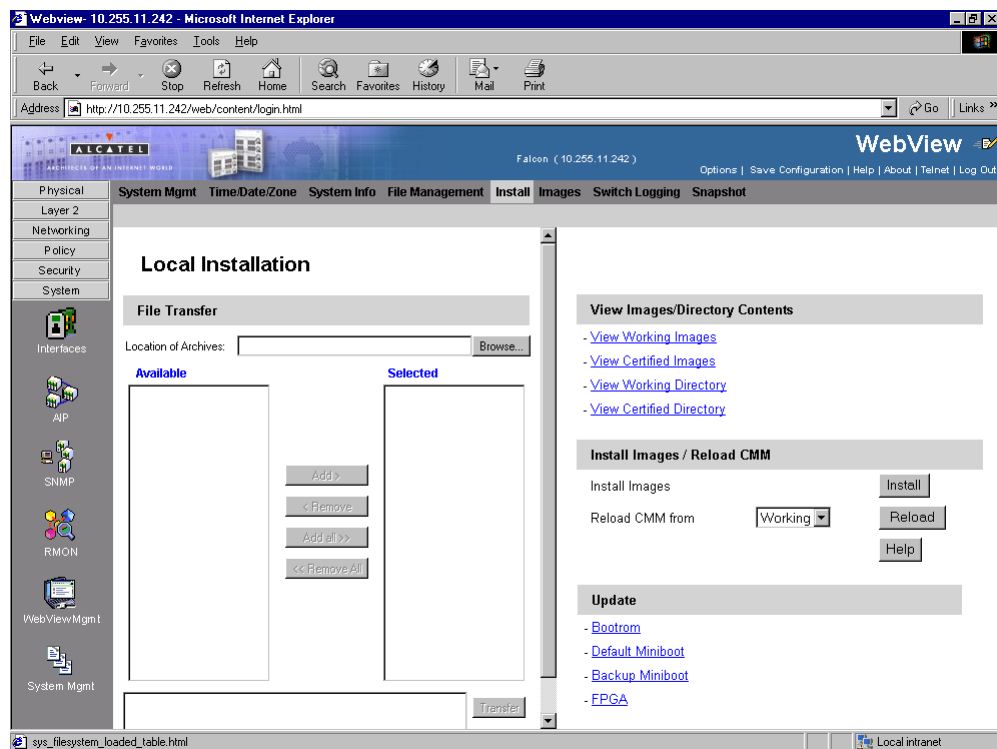

- 4 Click the **Install** button. The following pop-up window will be displayed:

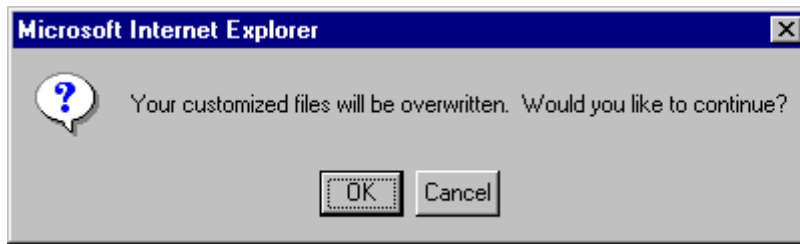

- 5 Click **OK**.
- 6 Select **Physical > Chassis Mgmt > CMM > Management** as shown below:

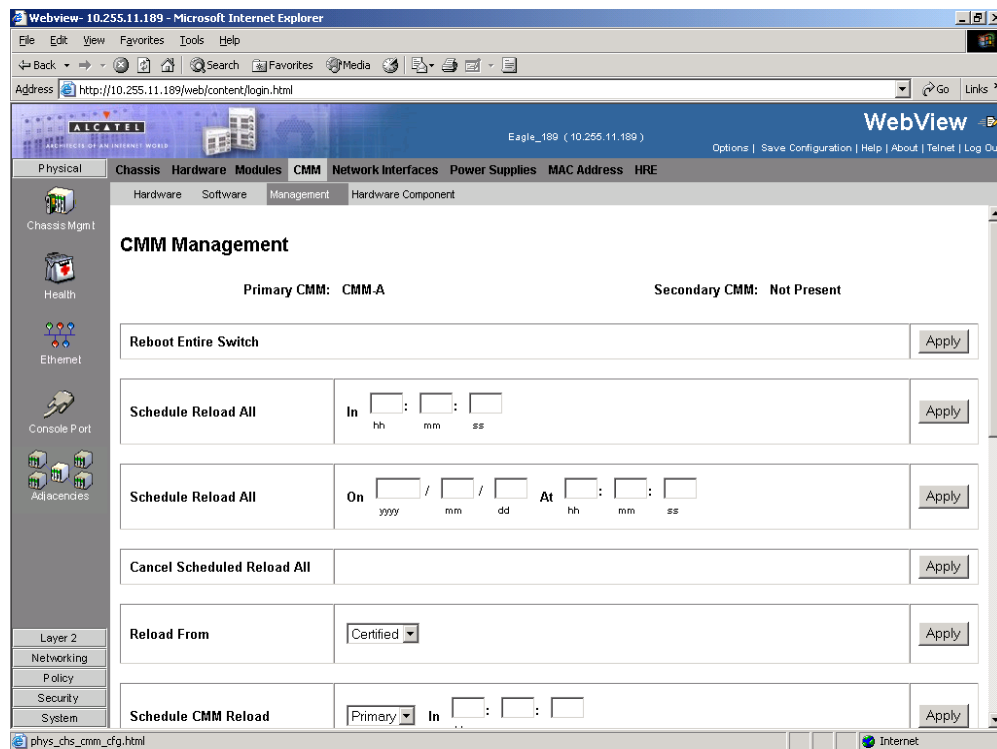

- 7 In the **Reload From** box Select **Working** and Click **Apply**. The following pop-up window will be displayed:

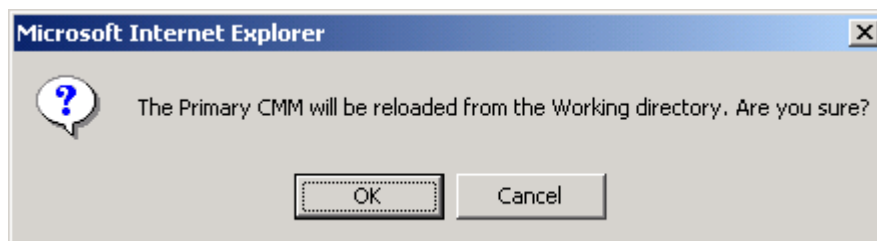

- 8 Click **OK**. The switch will now reboot to the new working version. (Wait for the command to finish executing.)
- 9 After the CMM finishes rebooting log into WebView.
- 10 Select **Physical > Chassis Mgmt > CMM > Management**.

11 If you have a single CMM select **Copy Working -> Certified on Primary** in the **Software Management** box as shown below:

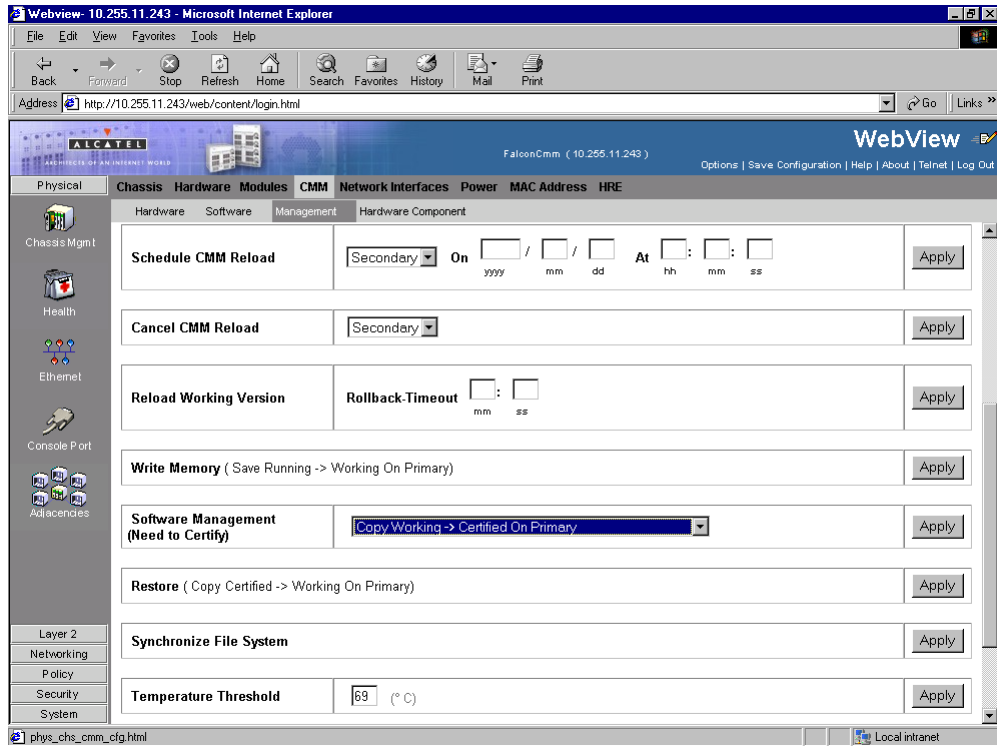

If you have dual CMMs select **Copy Working -> Certified & Synchronized with Secondary** in the **Software Management** box as shown below:

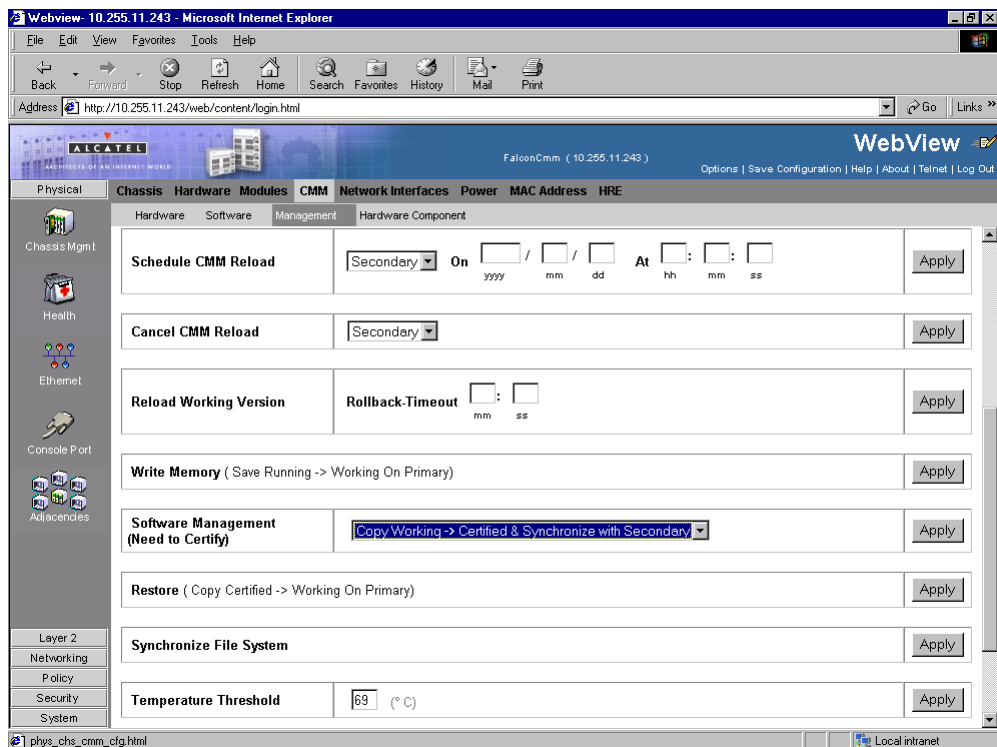

12 Click **Apply**. The following window will be displayed:



13 Click **OK**. The image file upgrade is complete. See [Verifying the Software with WebView on page 27](#) to confirm the upgrade.

Note. In dual CMM configurations the secondary CMM will reboot.

14 If the MiniBoot and BootROM are 5.4.1.455.R01 and the FPGA is 44 the upgrade to 5.1.6.R02 is now complete. (See [Verifying the Firmware with WebView on page 26](#) for more information.) If not, continue to [Step 15](#) below.

15 If the MiniBoot and BootROM are not 5.4.1.455.R01 continue to [Updating the MiniBoot/BootROM with WebView on page 8](#). (See [Verifying the Firmware with WebView on page 26](#) for more information.)

16 If the FPGA is not 44 continue to [Upgrading OmniSwitch 7700/7800 FPGA with WebView on page 13](#) or [Upgrading OmniSwitch 8800 FPGA with WebView on page 18](#). (See [Verifying the Firmware with WebView on page 26](#) for more information.)

If the image files are 5.1.6.R02, the MiniBoot and BootROM are 5.4.1.455.R01, and the FPGA is 44 the upgrade to 5.1.6.R02 is now complete. (See [Verifying the Upgrade with WebView on page 26](#) for more information.)

Updating the MiniBoot/BootROM with WebView

Follow the steps below to upgrade the MiniBoot and BootROM to 5.4.1.455.R01 with WebView. Please note that Release 5.1.6.R02 image files must be installed to use the steps in this procedure. See [Upgrading the Image Files with WebView on page 4](#) for more information.

WARNING. All CMMs must be certified and in redundant configurations both CMMs must be synchronized before beginning. In addition, the switch must be running in the Working directory. Use the **show running-directory** command to confirm these conditions.

- 1 Download the **bootrom.bin**, **miniboot.backup**, and **miniboot.default** files from the Alcatel's Service and Support code directory to the **/flash** directory.
- 2 Log into WebView.
- 3 Select **System > System Mgmt > Install** as shown below:

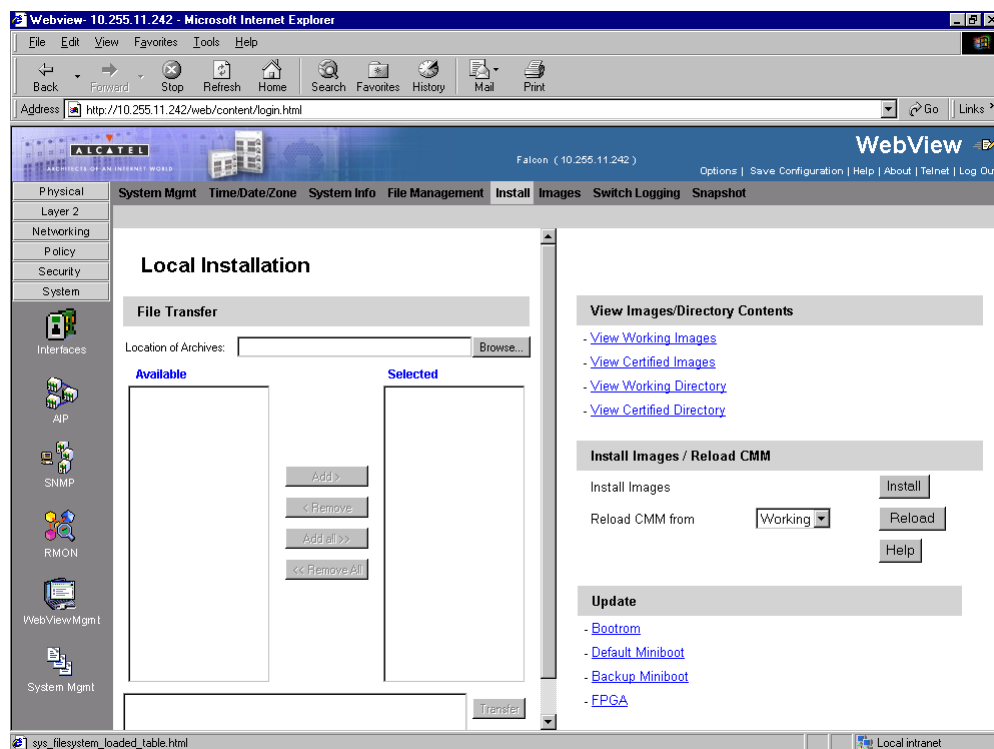

- 4 Select **Bootrom** in the **Update** box. The following confirmation window will be displayed:

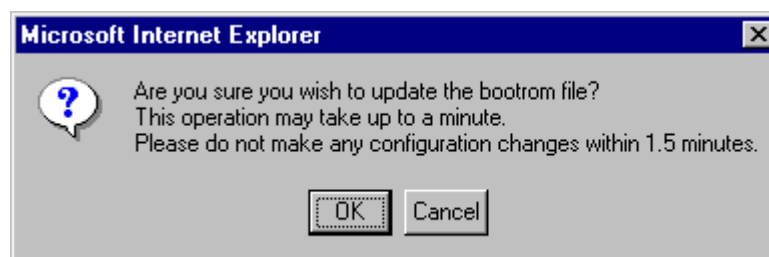

- 5 Click **OK**. Wait at least 1.5 minutes before proceeding to the next step.

- 6 Select **Default Miniboot** in the **Update** box. The following confirmation window will be displayed:

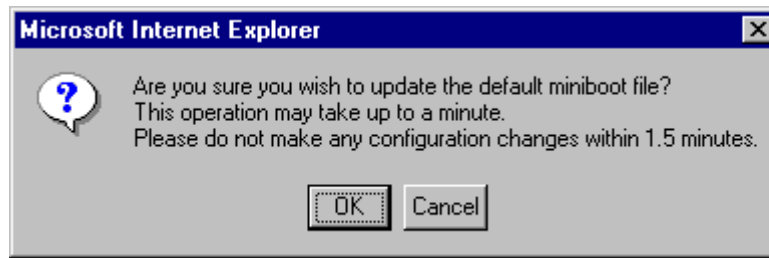

- 7 Click **OK**. Wait at least 1.5 minutes before proceeding to the next step.
- 8 Select **Backup Miniboot** in the **Update** box. The following confirmation window will be displayed:

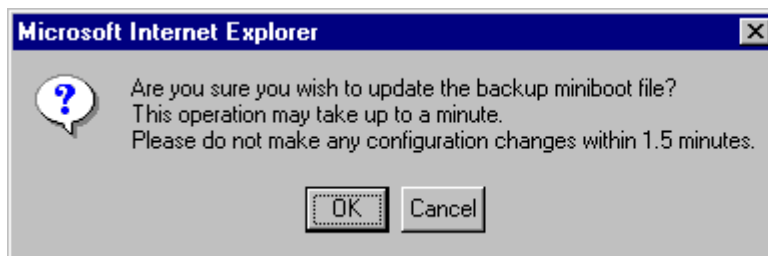

- 9 Click **OK**. Wait at least 1.5 minutes before proceeding to the next step.

Note. The MiniBoot and BootROM upgrades on the primary CMM are now complete. See [Verifying the Firmware with WebView on page 26](#) to confirm your upgrade.

- 10 Select **System > System Mgmt > File Management > Local** as shown below:

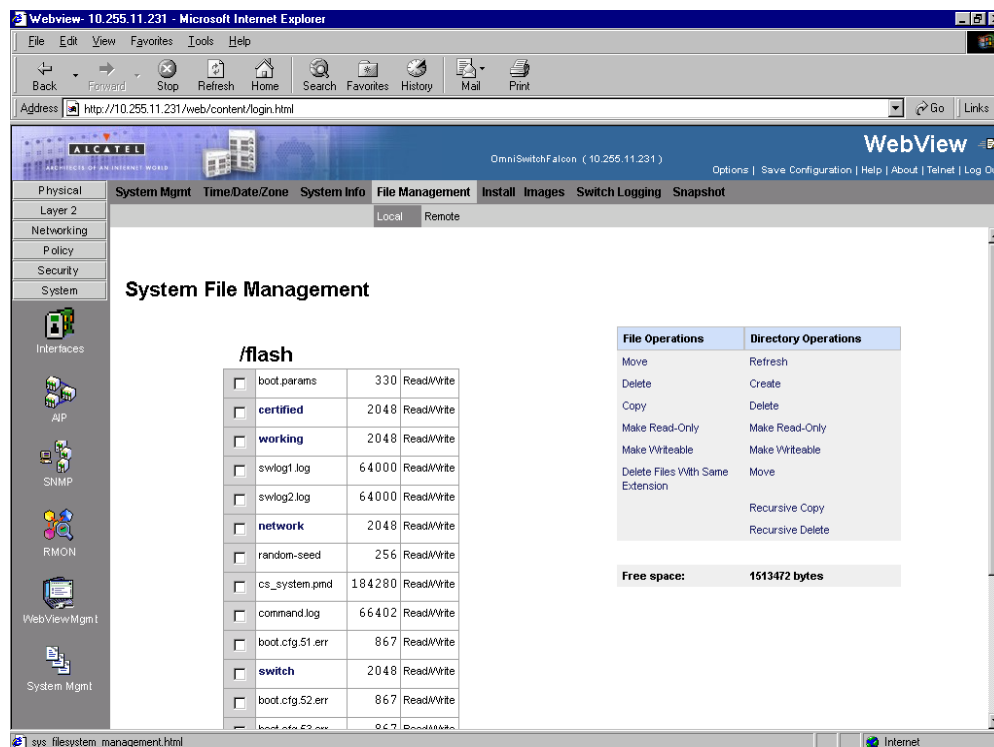

11 Check the box next to **bootrom.bin**.

12 Select **Delete** in the **File Operations** box. The following confirmation window will be displayed:

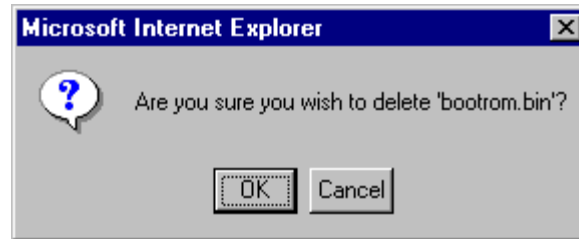

13 Click **OK**.

14 Check the box next to **miniboot.backup**.

15 Select **Delete** in the **File Operations** box. The following confirmation window will be displayed:

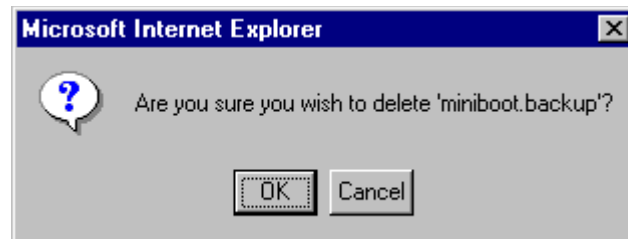

16 Click **OK**.

17 Check the box next to **miniboot.default**.

18 Select **Delete** in the **File Operations** box. The following confirmation window will be displayed:

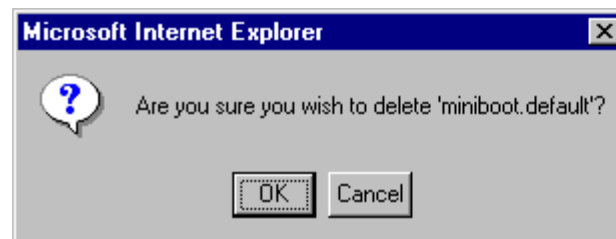

19 If you have dual CMMs proceed to [Step 20](#). Otherwise, proceed to [Step 27](#).

20 Select **System > System Mgmt > File Management > Remote** as shown below:

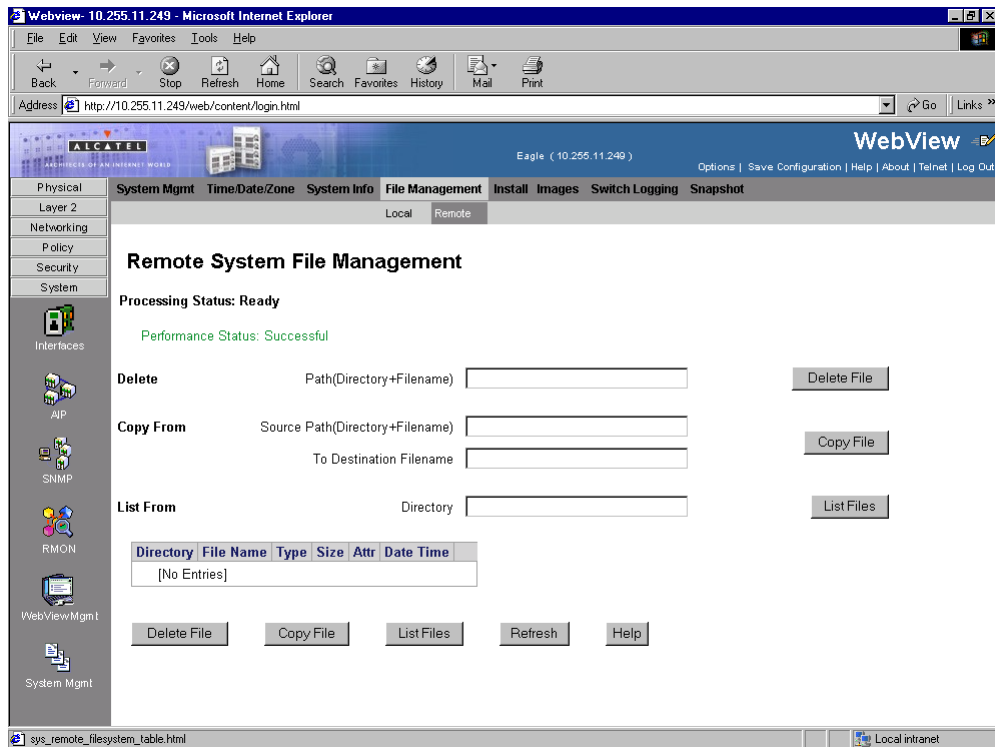

21 Enter **bootrom.bin** in the **Delete** box and click the **Delete File** to the right of this box. The following confirmation window will be displayed:

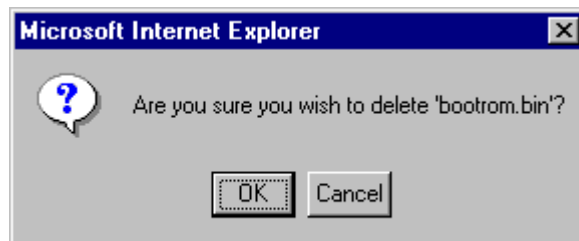

22 Click **OK**.

23 Enter **miniboot.backup** in the **Delete** box and click the **Delete File** to the right of this box. The following confirmation window will be displayed:

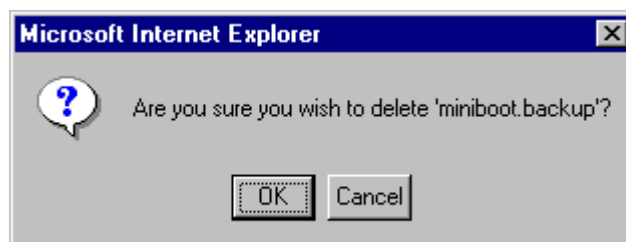

24 Click **OK**.

- 25** Enter **miniboot.default** in the **Delete** box and click the **Delete File** to the right of this box. The following confirmation window will be displayed:

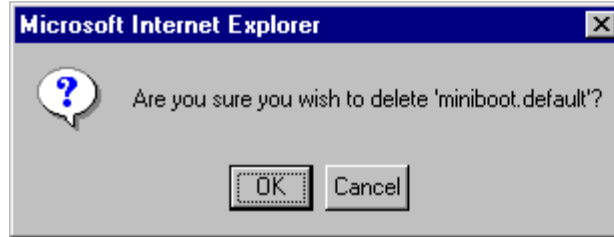

- 26** Click **OK**.
- 27** If the FPGA is 44 the upgrade to 5.1.6.R02 is now complete. (See [Verifying the Upgrade with WebView on page 26](#) for more information.) If not, continue to [Upgrading OmniSwitch 7700/7800 FPGA with WebView on page 13](#) or [Upgrading OmniSwitch 8800 FPGA with WebView on page 18](#).

Upgrading OmniSwitch 7700/7800 FPGA with WebView

Follow the steps below to upgrade the FPGA to FPGA 44 on OmniSwitch 7700/7800 switches. Please note that there must be 4.2 megabytes of free flash on each CMM.

CAUTION. By default, a shunt connecting pins 1 and 2 on jumper block J31 (OS7700-CMM) or jumper J345 (OS7800-CMM) is installed on all CMMs. (This jumper connection allows firmware upgrades on CMMs.) If this shunt has been removed and you need to upgrade your CMM's firmware, perform the steps in [Program Enable Jumpers Not Installed on page 38](#) in the [Troubleshooting](#) section before proceeding.

All CMMs must be running with 5.1.6.R02 image files before upgrading the FPGA. If you have not installed 5.1.6.R02 image files perform the steps described in [Upgrading the Image Files with WebView on page 4](#) before proceeding.

In addition, all CMMs must be running with BootROM/MiniBoot version 5.4.1.455.R01. If you have not upgraded the BootROM/MiniBoot version to 5.4.1.455.R01 perform the steps described in [Updating the MiniBoot/BootROM with WebView on page 8](#) before proceeding.

WARNING. Dual CMMs *must* have the same FPGA version number. Do not attempt to run switches with CMMs with different FPGA versions. See [Verifying the Firmware with WebView on page 26](#) for more information on viewing the current FPGA version.

- 1 Download the FPGA upgrade kit (**Ffpga.upgrade_kit** on OmniSwitch 7700/7800) from the Alcatel's Service and Support code directory to a source machine (e.g., a laptop).

WARNING. All CMMs must be certified and in redundant configurations both CMMs must be synchronized before beginning. In addition, the switch must be running in the Working directory. Use the **show running-directory** command to confirm these conditions.

- 2 FTP the FPGA upgrade kit file (**Ffpga.upgrade_kit** or **Efpga.upgrade_kit**) to the **/flash** directory on the primary CMM. Make sure you change the path of the destination directory from **/flash/working** (the default) to the root **/flash** directory before transferring the upgrade kit.
- 3 Log into WebView.

- 4 Select **System > System Mgmt > Install** as shown below:

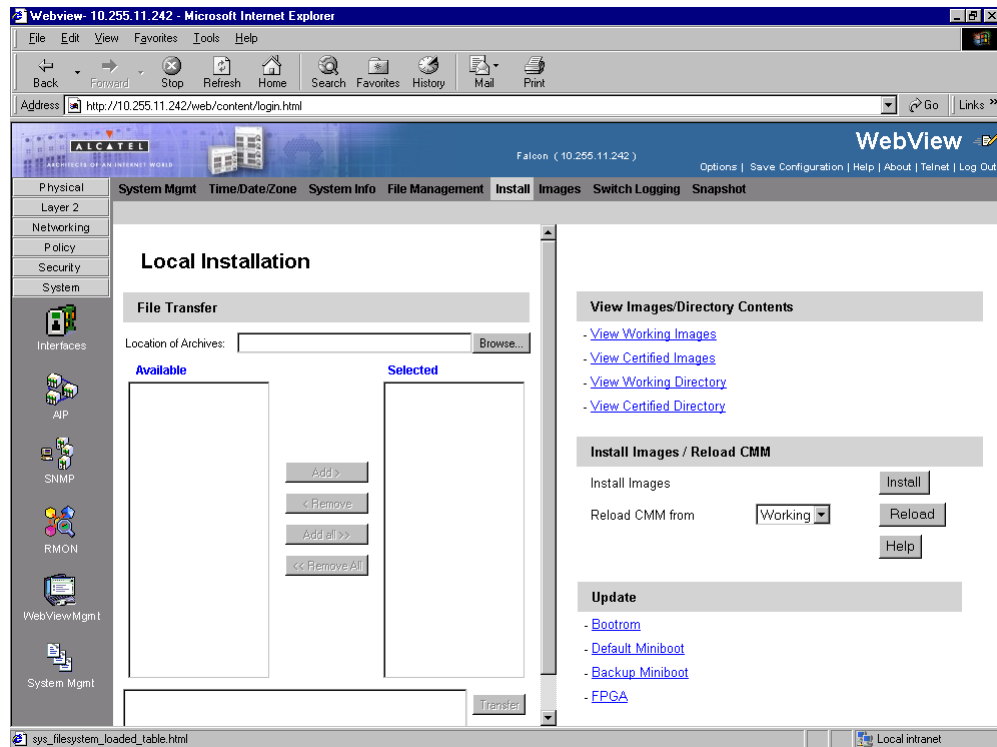

- 5 Select **FPGA** in the **Update** box. The following confirmation window will be displayed:

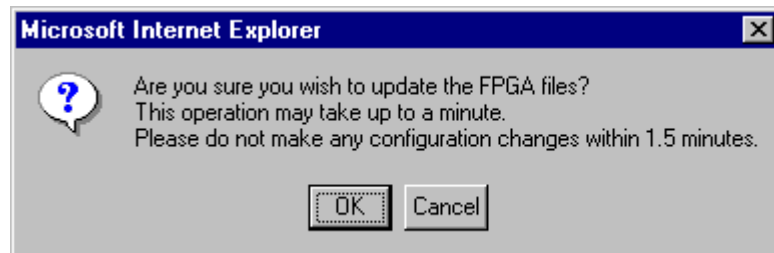

- 6 Click **OK**. Wait at least 1.5 minutes before proceeding to the next step.

7 Select **Physical > Chassis Mgmt > CMM > Management** as shown below:

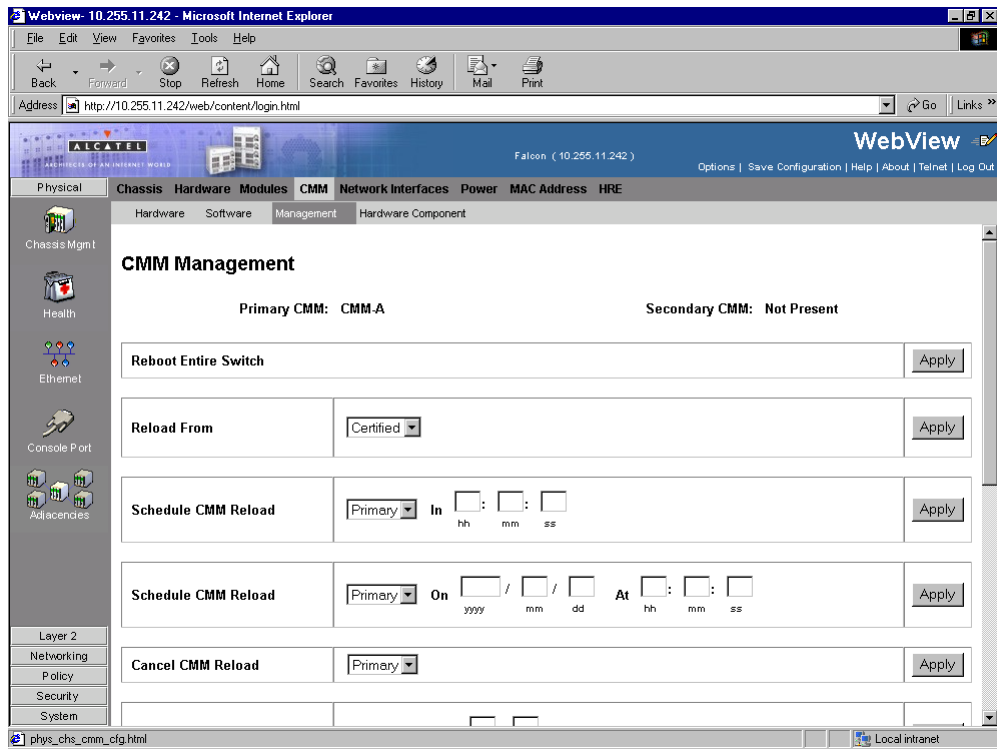

8 Select **Reboot Entire Switch** and Click **Apply**. The following pop-up window will be displayed:

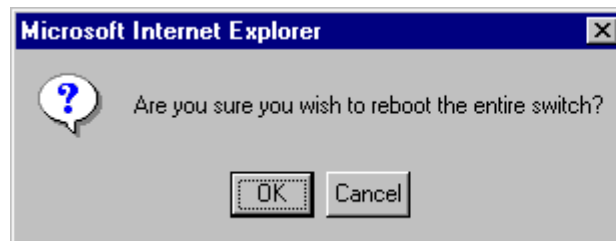

9 Click **OK**.

Note. If the image files are 5.1.6.R02, the MiniBoot and BootROM are 5.4.1.455.R01, and the FPGA is 44 the upgrade to 5.1.6.R02 is now complete. (See [Verifying the Upgrade with WebView](#) on page 26 for more information.)

After the FPGA upgrade has been successfully completed you should delete the FPGA upgrade kit file from the primary and secondary (if present) CMMs. Follow the steps below to delete these files:

- 1 Select **System > System Mgmt > File Management > Local** as shown below:

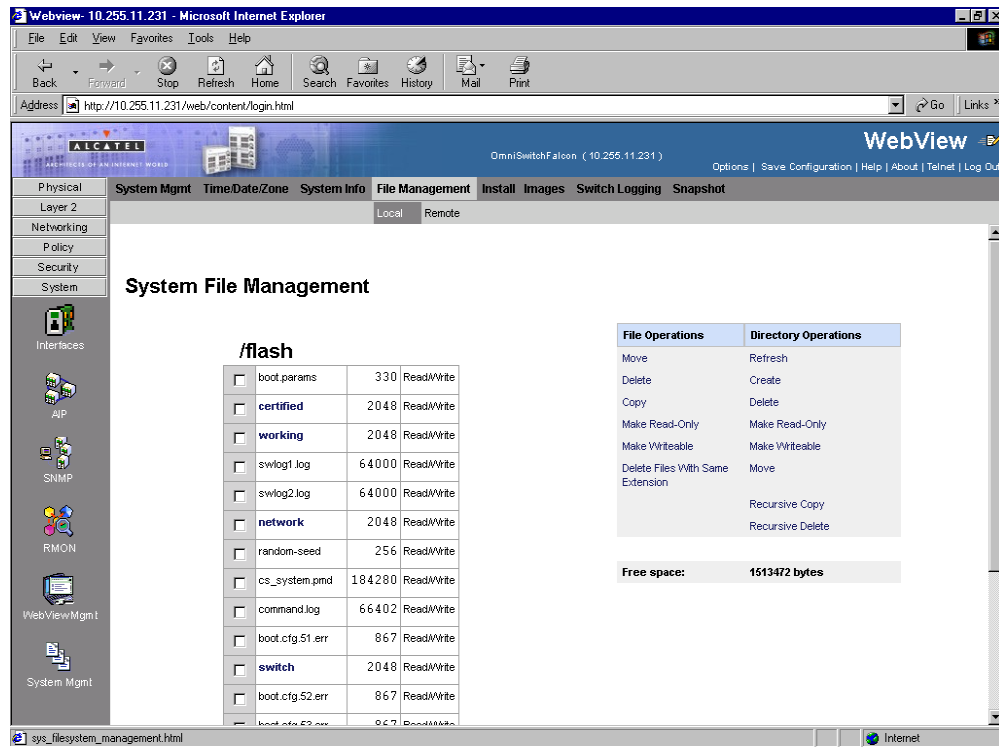

- 2 Check the box next to **Ffpga.upgrade_kit**.
- 3 Select **Delete** in the **File Operations** box. A confirmation window will be displayed.
- 4 Click **OK**.

Note. After the file is deleted the page will automatically refresh and show that the file has been deleted.

- 5 If you have a single CMM then you are done. If you have dual CMMs proceed to [Step 6](#).

- 6 Select **System > System Mgmt > File Management > Remote** as shown below:

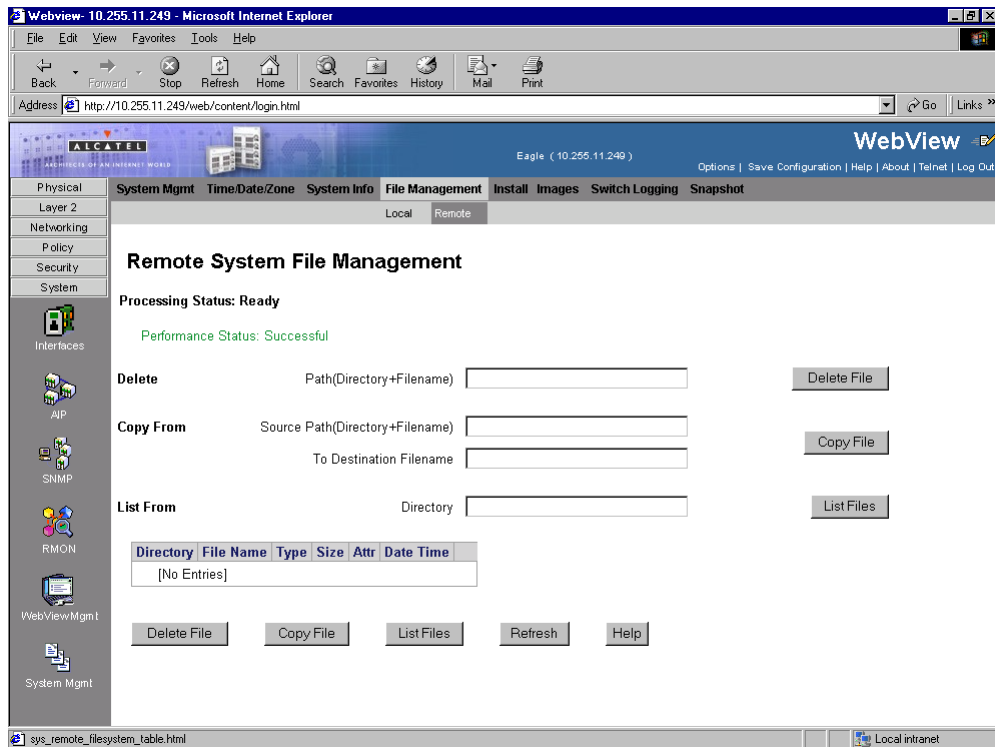

- 7 Enter **Ffpga.upgrade_kit** in the **Delete** box and click the **Delete File** to the right of this box.

A confirmation window will be displayed.

- 8 Click **OK**.

Note. After the file is deleted the page will automatically refresh and show that the file has been deleted.

Upgrading OmniSwitch 8800 FPGA with WebView

Follow the steps below to upgrade the FPGA to FPGA 44 on OmniSwitch 8800 switches. Please note that there must be 4.2 megabytes of free flash on each CMM.

CAUTION. By default, a shunt connecting pins 1 and 2 on jumper block J21 (OS8800-CMM) is installed on all CMMs. (This jumper connection allows firmware upgrades on CMMs.) If this shunt has been removed and you need to upgrade your CMM's firmware, perform the steps in [Program Enable Jumpers Not Installed on page 38](#) in the [Troubleshooting](#) section before proceeding.

All CMMs must be running with 5.1.6.R02 image files before upgrading the FPGA. If you have not installed 5.1.6.R02 image files perform the steps described in [Upgrading the Image Files with WebView on page 4](#) before proceeding.

In addition, all CMMs must be running with BootROM/MiniBoot version 5.4.1.455.R01. If you have not upgraded the BootROM/MiniBoot version to 5.4.1.455.R01 perform the steps described in [Updating the MiniBoot/BootROM with WebView on page 8](#) before proceeding.

WARNING. Dual CMMs *must* have the same FPGA version number. Do not attempt to run switches with CMMs with different FPGA versions. See [Verifying the Firmware with WebView on page 26](#) for more information on viewing the current FPGA version.

- 1 Download the FPGA upgrade kit (**Efpga.upgrade_kit**) from the Alcatel's Service and Support code directory to a source machine (e.g., a laptop).

WARNING. All CMMs must be certified and in redundant configurations both CMMs must be synchronized before beginning. In addition, the switch must be running in the Working directory. Use the **show running-directory** command to confirm these conditions.

- 2 FTP the FPGA upgrade kit file (**Efpga.upgrade_kit**) to the **/flash** directory on the primary CMM. Make sure you change the path of the destination directory from **/flash/working** (the default) to the root **/flash** directory before transferring the upgrade kit.
- 3 Log into WebView.

- 4 Select **System > System Mgmt > File Management > Local** as shown below:

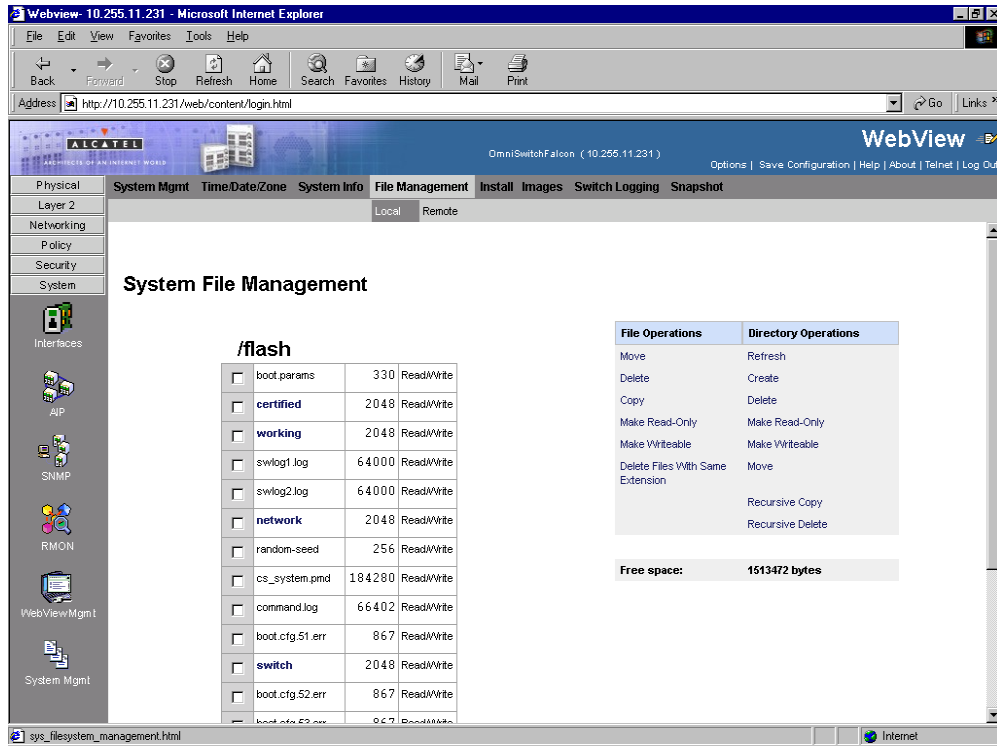

- 5 Navigate to the root **/flash** directory.
- 6 Click on **working** in the table. The following screen will be displayed:

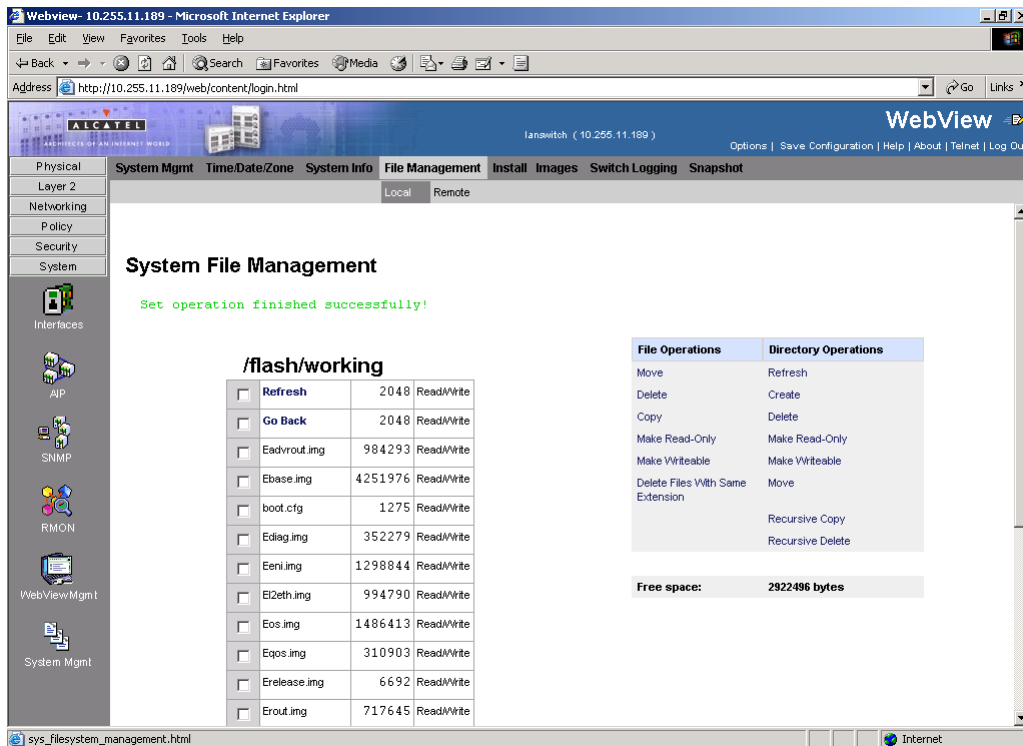

- 7 Check a box next to any file with a **.img** extension.
- 8 Click **Delete Files With The Same Extension**. A confirmation window will be displayed.
- 9 Click **OK**. Wait about one minute for the operation to complete.
- 10 If you have a single CMM proceed to [Step 14](#). Otherwise, select **System > System Mgmt > File Management > Remote** as shown below:

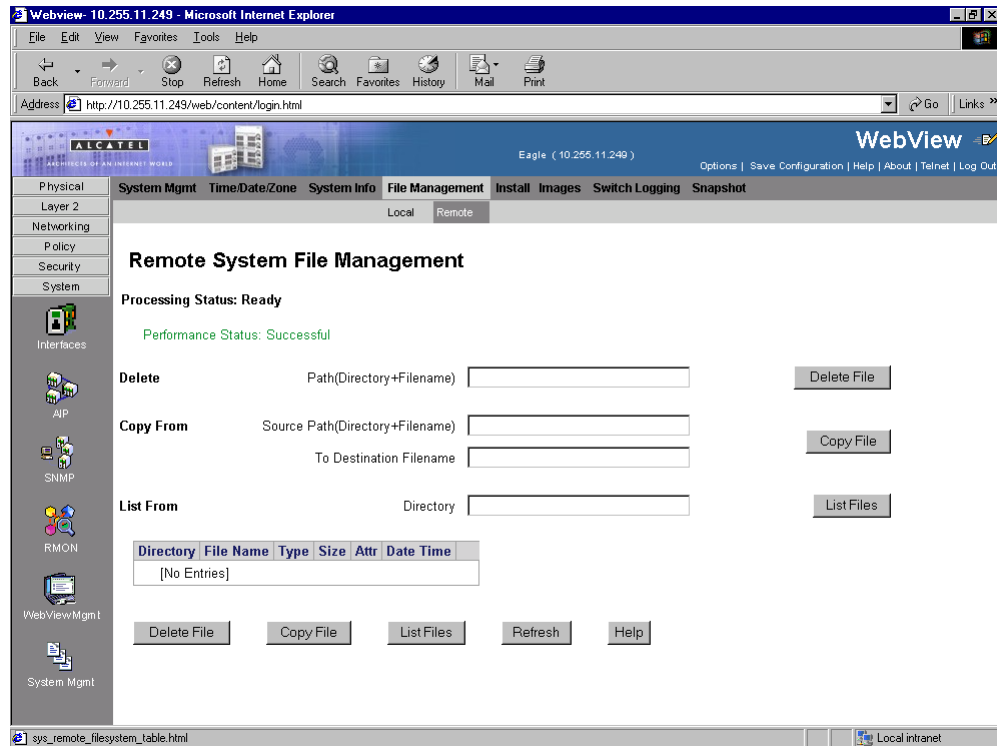

- 11 Enter `/flash/*.img` in the **Delete** box.
- 12 Click the **Delete** button next to the **Delete** box. A confirmation will be displayed.
- 13 Click **OK**. Wait about one minute for the operation to complete successfully.

14 Select **System > System Mgmt > Install** as shown below:

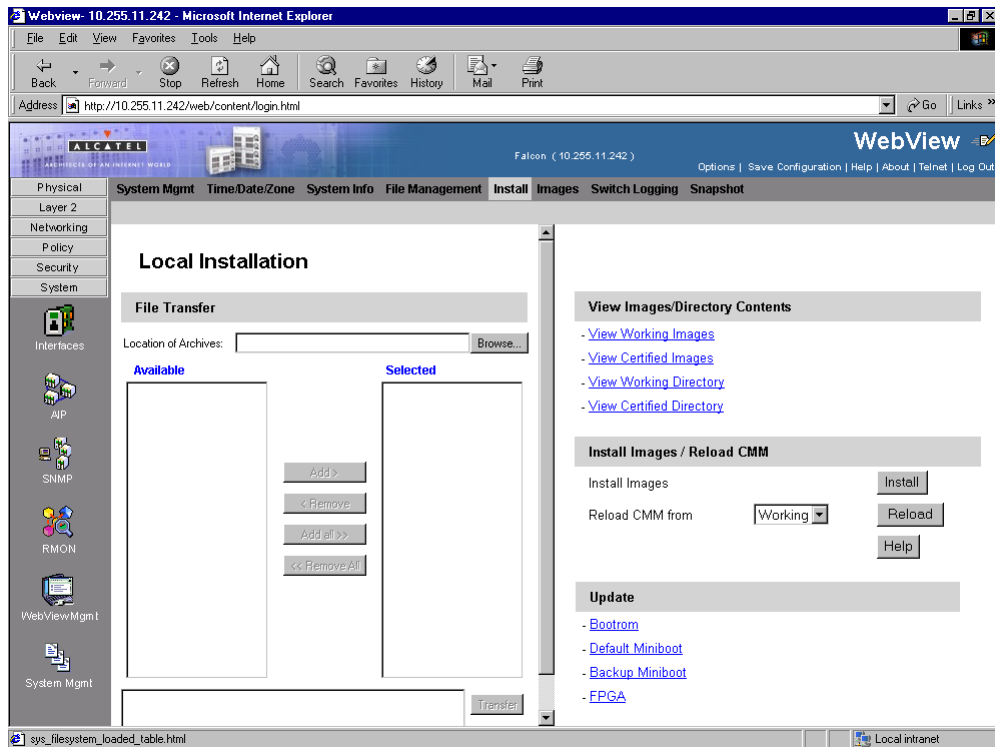

15 Select **FPGA** in the **Update** box. The following confirmation window will be displayed:

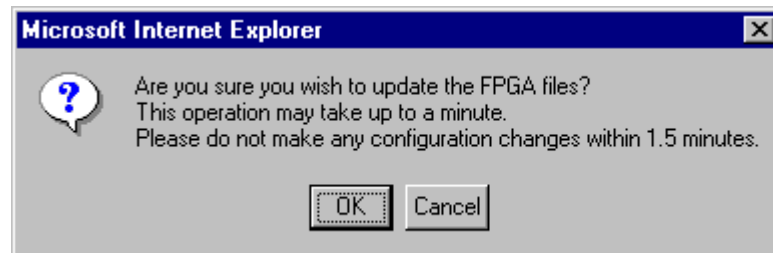

16 Click **OK**. Wait at least 1.5 minutes before proceeding to the next step.

17 Select **System > System Mgmt > File Management > Local** as shown below:

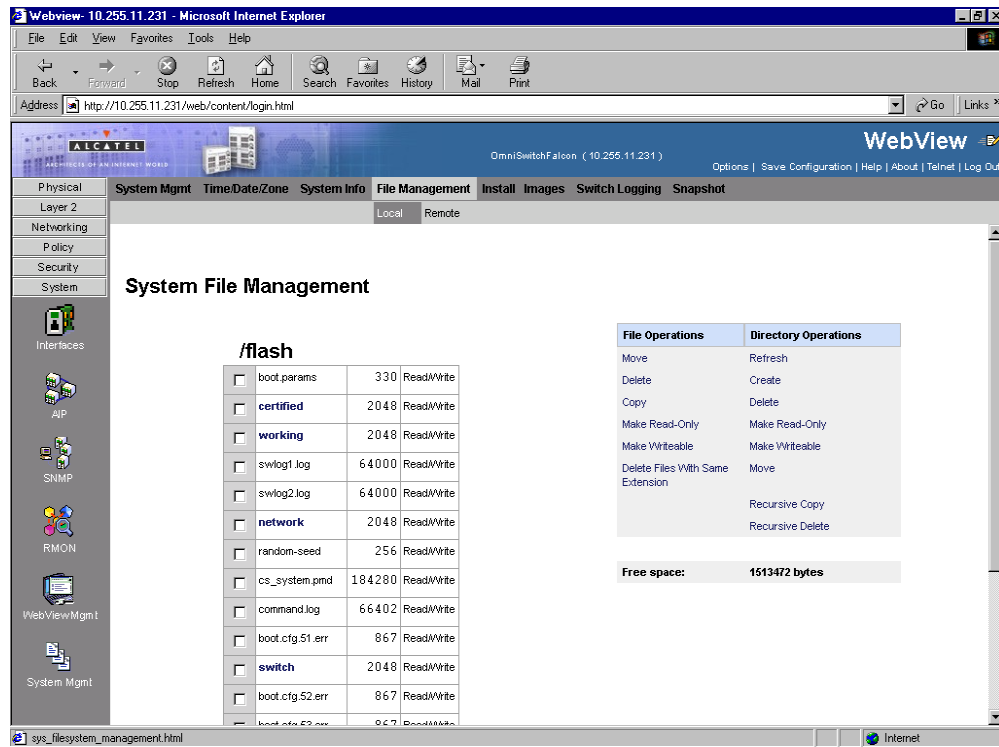

18 Check the box next to **Efpfga.upgrade_kit**.

19 Select **Delete** in the **File Operations** box. A confirmation window will be displayed.

20 Click **OK**.

Note. After the file is deleted the page will automatically refresh and show that the file has been deleted.

21 If you have a single CMM proceed to [Step 25](#). Otherwise, proceed to [Step 22](#).

22 Select **System > System Mgmt > File Management > Remote** as shown below:

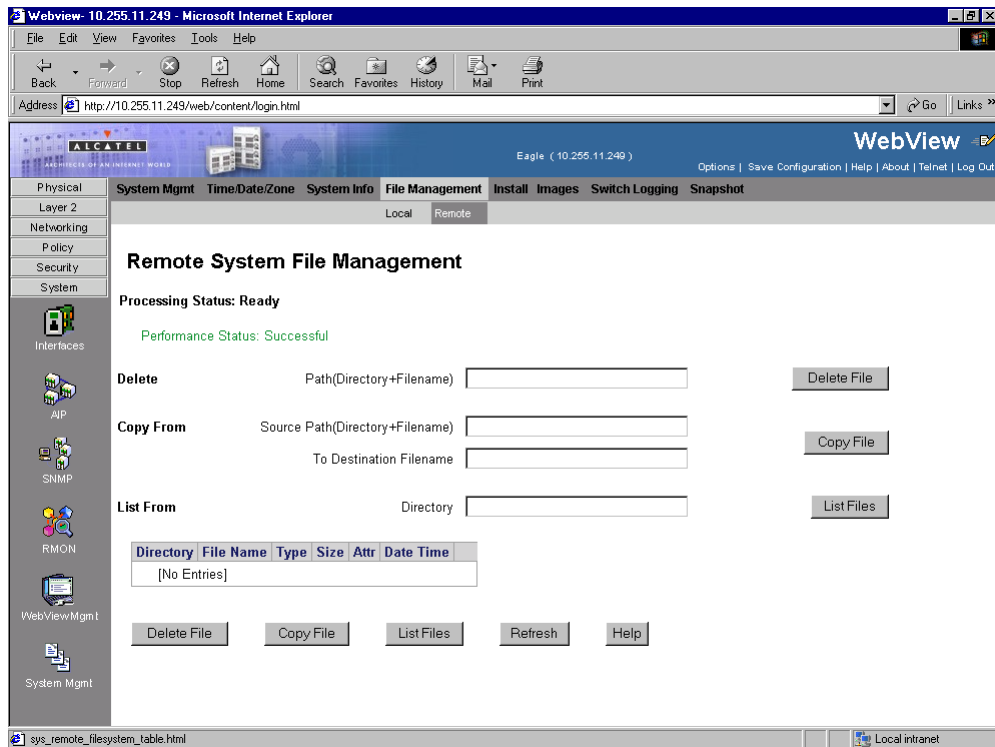

23 Enter **Efpga.upgrade_kit** in the **Delete** box and click the **Delete File** to the right of this box.

A confirmation window will be displayed.

24 Click **OK**.

Note. After the file is deleted the page will automatically refresh and show that the file has been deleted.

25 Select **Physical > Chassis Mgmt > CMM > Management** as shown below:

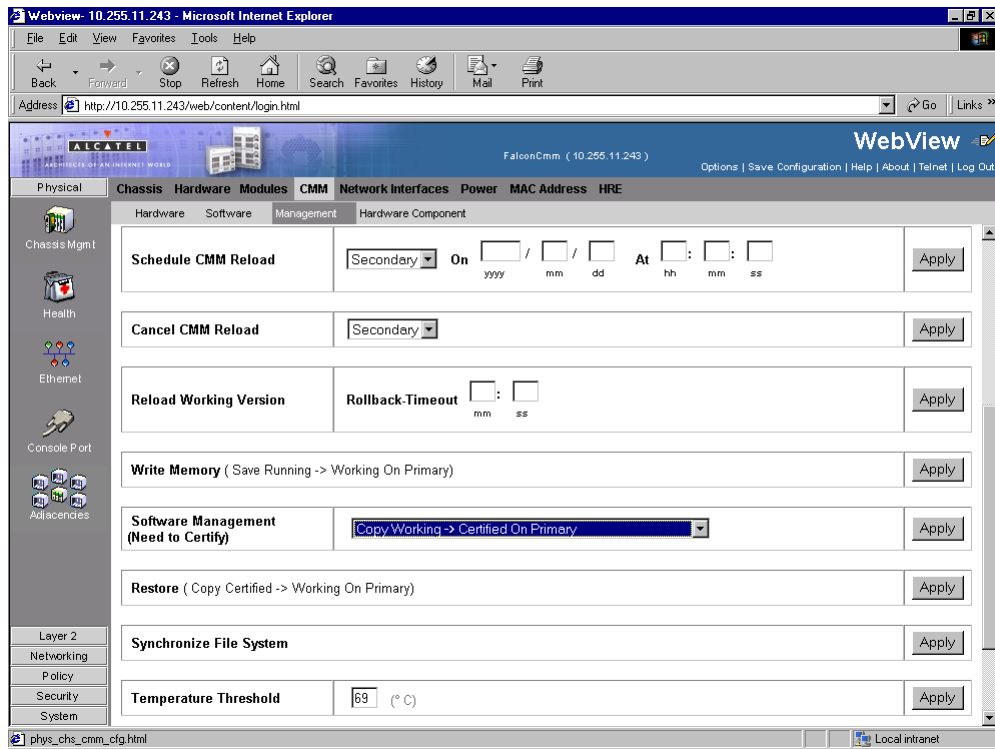

26 Click **Apply** next to the **Copy Certified > Working On Primary** box.

27 If you have a single CMM proceed to [Step 29](#). Otherwise, proceed to [Step 28](#).

28 Click **Apply** next to the **Synchronize File System** box.

29 Select **Physical > Chassis Mgmt > CMM > Management** as shown below:

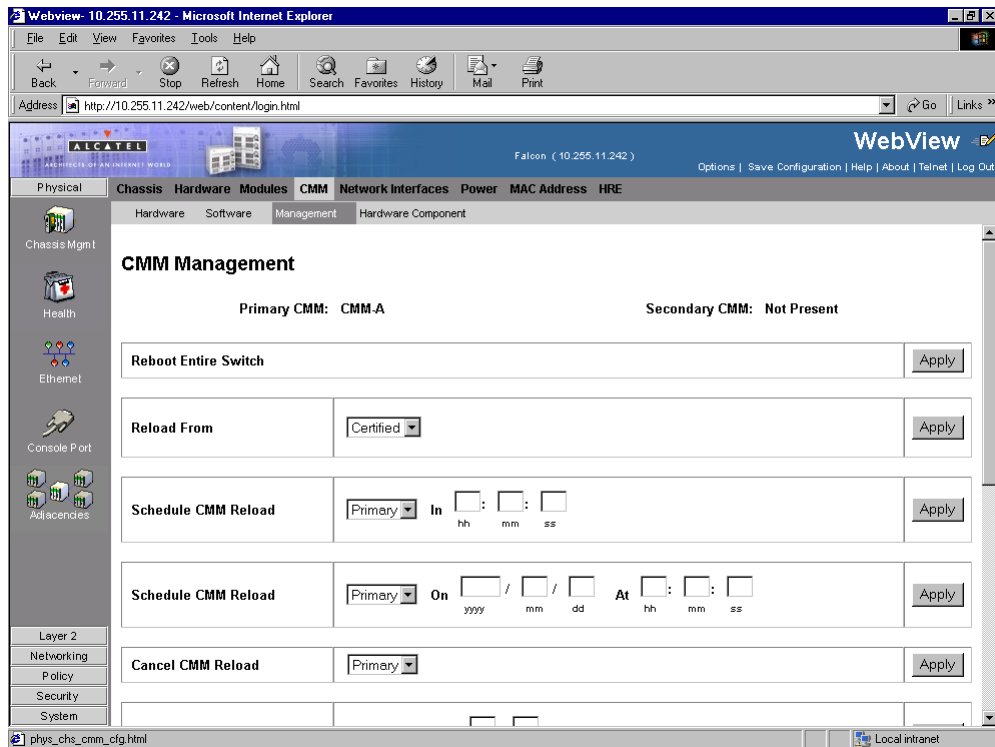

30 Select **Reboot Entire Switch** and Click **Apply**. The following pop-up window will be displayed:

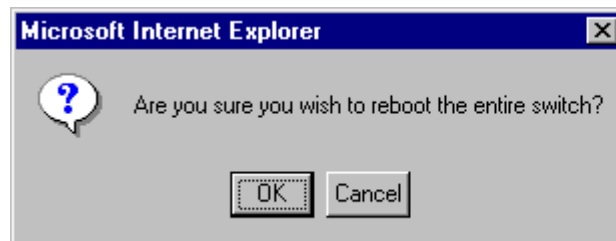

31 Click **OK**.

Note. If the image files are 5.1.6.R02, the MiniBoot and BootROM are 5.4.1.455.R01, and the FPGA is 44 the upgrade to 5.1.6.R02 is now complete. (See [Verifying the Upgrade with WebView](#) on page 26 for more information.)

After the FPGA upgrade has been successfully completed you should delete the FPGA upgrade kit file from the primary and secondary (if present) CMMs. Follow the steps below to delete these files:

Verifying the Upgrade with WebView

You can use WebView to verify that your upgrade is successful.

Verifying the Firmware with WebView

To verify that the CMM's firmware was correctly upgraded to FPGA 44 and to verify that the MiniBoot/BootROM has been successfully upgraded to 5.4.1.455.R01 on OmniSwitch 7700, 7800, and 8800 switches, select **Physical > Chassis Mgmt > CMM > Hardware Component** as shown below:

The screenshot shows the Alcatel WebView interface for a switch. The navigation path is Physical > Chassis Mgmt > CMM > Hardware Component. The main content area displays 'CMM Hardware Component Information' with a table of hardware details. The table includes fields for Flash Manufacturer, Flash Size, RAM Manufacturer, RAM Size, NVRAM Battery Status, CPU Type, and various jumper settings. The 'BootROM Version', 'Backup Miniboot Version', and 'Default Miniboot Version' are all listed as '5.4.1.455.R01'. The 'FPGA Version' is listed as '44'. There are 'Refresh' and 'Help' buttons at the bottom of the table.

Flash Manufacturer	Amd
Flash Size (bytes)	33554432
RAM Manufacturer	Other
RAM Size (bytes)	123731968
NVRAM Battery Status	Ok
CPU Type	SparcV9
Interrupt Boot Jumper	Enable
Force UART Defaults Jumper	Enable
Run Extended Memory Diags Jumper	Disable
Spare Jumper	Enable
BootROM Version	5.4.1.455.R01
Backup Miniboot Version	5.4.1.455.R01
Default Miniboot Version	5.4.1.455.R01
FPGA Version	44

The MiniBoot and BootROM have been correctly updated to 5.4.1.455.R01

The firmware has been correctly updated to FPGA 44.

Verifying the Software with WebView

To verify that the software was correctly upgraded to 5.1.6.R02, select **System > System Mgmt > Images > Loaded Images** as shown below:

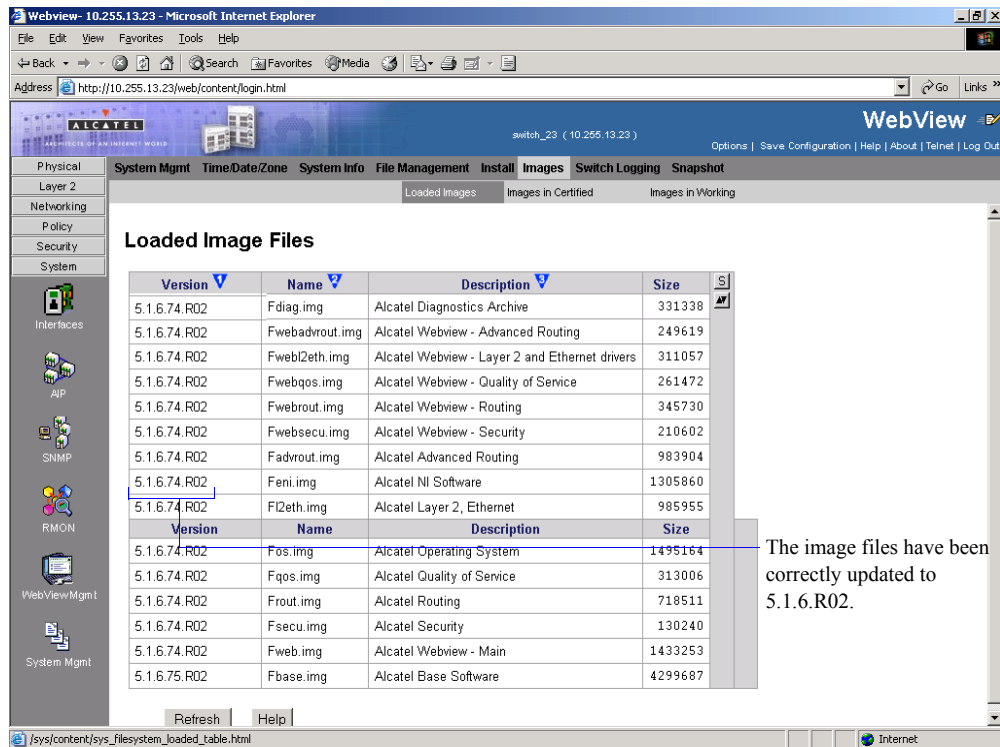

The screenshot shows the WebView interface for switch_23 (10.255.13.23). The navigation menu includes Physical, Layer 2, Networking, Policy, Security, and System. The System Mgmt section is expanded, showing options like Time/Date/Zone, System Info, File Management, Install, Images, Switch Logging, and Snapshot. The 'Images' section is further expanded to show 'Loaded Images', 'Images in Certified', and 'Images in Working'. The 'Loaded Image Files' table is displayed with the following data:

Version	Name	Description	Size
5.1.6.74.R02	Fdiag.img	Alcatel Diagnostics Archive	331338
5.1.6.74.R02	Fwebadvrout.img	Alcatel Webview - Advanced Routing	249619
5.1.6.74.R02	Fweb2eth.img	Alcatel Webview - Layer 2 and Ethernet drivers	311057
5.1.6.74.R02	Fwebqos.img	Alcatel Webview - Quality of Service	261472
5.1.6.74.R02	Fwebroutr.img	Alcatel Webview - Routing	345730
5.1.6.74.R02	Fwebsecu.img	Alcatel Webview - Security	210602
5.1.6.74.R02	Fadvrout.img	Alcatel Advanced Routing	983904
5.1.6.74.R02	Feni.img	Alcatel NI Software	1305860
5.1.6.74.R02	FI2eth.img	Alcatel Layer 2, Ethernet	985955
5.1.6.74.R02	Fos.img	Alcatel Operating System	1495164
5.1.6.74.R02	Fqos.img	Alcatel Quality of Service	313006
5.1.6.74.R02	Froutr.img	Alcatel Routing	718511
5.1.6.74.R02	Fsecu.img	Alcatel Security	130240
5.1.6.74.R02	Fweb.img	Alcatel Webview - Main	1433253
5.1.6.75.R02	Fbase.img	Alcatel Base Software	4299687

In addition, you should also select **System > System Mgmt > Images > Images in Certified** and **System > System Mgmt > Images > Images in Working** to verify that Certified and Working directories have been correctly upgraded to Release 5.1.6.R02.

Note. Refer to the online help and to the *OmniSwitch 7700/7800/8800 Switch Management Guide* for more documentation on WebView.

Upgrading the Image Files with the CLI

Follow the steps below to upgrade the image files on OmniSwitch 7700/7800/8800 switches to Release 5.1.6.R02 through the CLI. You should review all steps in this procedure before beginning.

Caution. Do not FTP the **miniboot.default**, **miniboot.backup**, **bootrom.bin**, and FPGA files at this time. See the related sections for those instructions.

Recommendation. release 5.1.6.R02 configuration files are *not* backwards compatible to Release 5.1.5 and earlier. Therefore, Alcatel recommends that you back up your configuration files before beginning.

1 FTP the 5.1.6.R02 image files to the **/flash/working** directory.

Note. If you have dual CMMs make sure you FTP the files to the primary CMM.

2 Log into the CMM.

Note. In dual CMM configurations you must log into the primary CMM.

3 At the CLI prompt enter:

```
-> install *.img
```

4 When prompted to install the WebView security image file (**Fwebsecu.img** on OmniSwitch 7700/7800 and **Ewebsecu.img** on OmniSwitch 8800) answer **y**.

5 Enter:

```
-> reload working no rollback-timeout
```

The switch will now reboot to the new working version.

6 Log into the CMM.

Note. In dual CMM configurations you must log into the primary CMM.

7 If you have a single CMM enter:

```
-> copy working certified
```

If you have dual CMMs enter:

```
-> copy working certified flash-synchro
```

Wait for the command to finish executing.

Note. In dual CMM configurations the secondary CMM will reboot.

- 8** If the MiniBoot and BootROM are 5.4.1.455.R01 and the FPGA is 44 the upgrade to 5.1.6.R02 is now complete. (See [Verifying the Upgrade with the CLI on page 37](#) for more information.) If not, continue to [Step 9](#) on [Page 29](#).
- 9** If the MiniBoot and BootROM are not 5.4.1.455.R01 continue to [Updating the MiniBoot/BootROM with the CLI on page 30](#). (See [Verifying the Upgrade with the CLI on page 37](#) for more information.)
- 10** If the FPGA is not 44 continue to [Upgrading OmniSwitch 7700/7800 FPGA with the CLI on page 32](#) or [Upgrading OmniSwitch 8800 FPGA with the CLI on page 34](#). (See [Verifying the Upgrade with the CLI on page 37](#) for more information.)

If the image files are 5.1.6.R02, the MiniBoot and BootROM are 5.4.1.455.R01, and the FPGA is 44 the upgrade to 5.1.6.R02 is now complete. (See [Verifying the Upgrade with the CLI on page 37](#) for more information.)

Updating the MiniBoot/BootROM with the CLI

Follow the steps below to upgrade the MiniBoot and BootROM to 5.4.1.455.R01. Please note that Release 5.1.6.R02 image files must be installed to use the steps in this procedure. See [Upgrading the Image Files with the CLI on page 28](#) for more information.

WARNING. All CMMs must be certified and in redundant configurations both CMMs must be synchronized before beginning. In addition, the switch must be running in the Working directory. Use the **show running-directory** command to confirm these conditions.

- 1 Download the **bootrom.bin**, **miniboot.backup**, and **miniboot.default** files from the Alcatel's Service and Support code directory to the **/flash** directory on the primary CMM.
- 2 Log into the CMM.

Note. In dual CMM configurations you must log into the primary CMM.

3 Enter

```
-> update bootrom
```

Wait for the following message to be displayed:

```
"-- SESSION END --"
```

4 Enter

```
-> update miniboot default
```

Wait for the following message to be displayed:

```
"-- SESSION END --"
```

5 Enter

```
-> update miniboot backup
```

Wait for the following message to be displayed:

```
"-- SESSION END --"
```

6 Enter:

```
-> rm bootrom.bin
```

7 Enter:

```
-> rm miniboot.default
```

8 Enter:

```
-> rm miniboot.backup
```

Note. Use the **ls** command to confirm that the files have been deleted on the primary CMM.

9 If you have dual CMMs go to [Step 10](#) below. Otherwise, go to [Step 13](#).

Note. Steps [10](#) through [12](#) must be performed on the primary CMM.

10 Enter:

```
-> rrm /flash/bootrom.bin
```

11 Enter:

```
-> rrm /flash/miniboot.default
```

12 Enter:

```
-> rrm /flash/miniboot.backup
```

13 If the FPGA is 44 the upgrade to 5.1.6.R02 is now complete. (See [Verifying the Upgrade with the CLI on page 37](#) for more information.) If not, continue to [Upgrading OmniSwitch 7700/7800 FPGA with the CLI on page 32](#) or [Upgrading OmniSwitch 8800 FPGA with the CLI on page 34](#).

Note. Use the **rls** command by entering

```
-> rls /flash
```

to confirm that the files have been deleted on the secondary CMM.

If the image files are 5.1.6.R02, the MiniBoot and BootROM are 5.4.1.455.R01, and the FPGA is 44 the upgrade to 5.1.6.R02 is now complete. (See [Verifying the Upgrade with the CLI on page 37](#) for more information.)

Upgrading OmniSwitch 7700/7800 FPGA with the CLI

Follow the steps below to upgrade the FPGA to FPGA 44 on OmniSwitch 7700/7800/ switches. Please note that there must be 4.2 megabytes of free flash on each CMM.

CAUTION. By default, a shunt connecting pins 1 and 2 on jumper block J31 (OS7700-CMM) or jumper J345 (OS7800-CMM) is installed on all CMMs. (This jumper connection allows firmware upgrades on CMMs.) If this shunt has been removed and you need to upgrade your CMM's firmware, perform the steps in [Program Enable Jumpers Not Installed on page 38](#) in the [Troubleshooting](#) section before proceeding.

All CMMs must be running with 5.1.6.R02 image files before upgrading the FPGA. If you have not installed 5.1.6.R02 image files perform the steps described in [Upgrading the Image Files with the CLI on page 28](#) before proceeding.

In addition, all CMMs must be running with BootROM/MiniBoot version 5.4.1.455.R01. If you have not upgraded the BootROM/MiniBoot version to 5.4.1.455.R01 perform the steps described in [Updating the MiniBoot/BootROM with the CLI on page 30](#) before proceeding.

WARNING. Dual CMMs *must* have the same FPGA version number. Do not attempt to run switches with CMMs with different FPGA versions. See [Verifying the Upgrade with the CLI on page 37](#) for more information on viewing the current FPGA version.

- 1 Download the FPGA upgrade kit (**Ffpga.upgrade_kit**) from the Alcatel's Service and Support code directory to a source machine (e.g., a laptop).

WARNING. All CMMs must be certified and in redundant configurations both CMMs must be synchronized before beginning. In addition, the switch must be running in the Working directory. Use the **show running-directory** command to confirm these conditions.

- 2 FTP the FPGA upgrade kit file (**Ffpga.upgrade_kit**) to the **/flash** directory on the primary CMM. Make sure you change the path of the destination directory from **/flash/working** (the default) to the root **/flash** directory before transferring the upgrade kit.
- 3 Log into the CMM.

Note. In dual CMM configurations you must log into the primary CMM.

4 Enter:

```
-> update fpga cmm
```

Wait for the following message to be displayed:

```
"-- SESSION END --"
```

Note. This command may take as much as a minute before it completes, particularly in single CMM configurations.

5 Power cycle the switch or use the **reload all** command.

Note. If the image files are 5.1.6.R02, the MiniBoot and BootROM are 5.4.1.455.R01, and the FPGA is 44 the upgrade to 5.1.6.R02 is now complete. (See [Verifying the Upgrade with the CLI on page 37](#) for more information.)

After the FPGA upgrade has been successfully completed you should delete the FPGA upgrade kit file from the primary and secondary (if present) CMMs. Follow the steps below to delete these files:

1 Enter the following to delete the **Ffpga.upgrade_kit** file on the primary CMM:

```
-> rm Ffpga.upgrade_kit
```

Note. Use the **ls** command to confirm that the upgrade kit file has been deleted on the primary CMM.

2 Enter the following on the primary CMM to delete the **Ffpga.upgrade_kit** file on the secondary CMM:

```
-> rrm /flash/Ffpga.upgrade_kit
```

Note. Use the **rls** command by entering:

```
-> rls /flash
```

to confirm that the upgrade kit file has been deleted on the secondary CMM.

Upgrading OmniSwitch 8800 FPGA with the CLI

Follow the steps below to upgrade the FPGA to FPGA 44 on OmniSwitch 7700/7800/8800 switches. Please note that there must be 4.2 megabytes of free flash on each CMM.

CAUTION. By default, a shunt connecting pins 1 and 2 on jumper block J21 (OS8800-CMM) is installed on all CMMs. (This jumper connection allows firmware upgrades on CMMs.) If this shunt has been removed and you need to upgrade your CMM's firmware, perform the steps in [Program Enable Jumpers Not Installed on page 38](#) in the [Troubleshooting](#) section before proceeding.

All CMMs must be running with 5.1.6.R02 image files before upgrading the FPGA. If you have not installed 5.1.6.R02 image files perform the steps described in [Upgrading the Image Files with the CLI on page 28](#) before proceeding.

In addition, all CMMs must be running with BootROM/MiniBoot version 5.4.1.455.R01. If you have not upgraded the BootROM/MiniBoot version to 5.4.1.455.R01 perform the steps described in [Updating the MiniBoot/BootROM with the CLI on page 30](#) before proceeding.

WARNING. Dual CMMs *must* have the same FPGA version number. Do not attempt to run switches with CMMs with different FPGA versions. See [Verifying the Upgrade with the CLI on page 37](#) for more information on viewing the current FPGA version.

- 1 Download the FPGA upgrade kit (**Efpga.upgrade_kit**) from the Alcatel's Service and Support code directory to a source machine (e.g., a laptop).

WARNING. All CMMs must be certified and in redundant configurations both CMMs must be synchronized before beginning. In addition, the switch must be running in the Working directory. Use the **show running-directory** command to confirm these conditions.

- 2 FTP the FPGA upgrade kit file (**Efpga.upgrade_kit**) to the **/flash** directory on the primary CMM. Make sure you change the path of the destination directory from **/flash/working** (the default) to the root **/flash** directory before transferring the upgrade kit.
- 3 Log into the CMM.

Note. In dual CMM configurations you must log into the primary CMM.

- 4 Change to the **Working** directory by entering:

```
-> cd working
```

- 5 Remove the image files from primary CMM by entering:

```
-> rm *.img
```

- 6** If you have a secondary CMM enter the following commands. If you have a single CMM proceed to [Step 7](#).

```
-> rrm /flash/working/Ewebsecu.img
-> rrm /flash/working/Ewebroun.img
-> rrm /flash/working/Ewebqos.img
-> rrm /flash/working/Eweb12eth.img
-> rrm /flash/working/Ewebadvroun.img
-> rrm /flash/working/Eweb.img
-> rrm /flash/working/Esecu.img
-> rrm /flash/working/Erelease.img
-> rrm /flash/working/Erout.img
-> rrm /flash/working/Eqos.img
-> rrm /flash/working/Eos.img
-> rrm /flash/working/E12eth.img
-> rrm /flash/working/Eeni.img
-> rrm /flash/working/Ediag.img
-> rrm /flash/working/Ebase.img
-> rrm /flash/working/Eadvroun.img
```

- 7** Enter:

```
-> update fpga cmm
```

Wait for the following message to be displayed:

```
"-- SESSION END --"
```

Note. This command may take as much as a minute before it completes, particularly in single CMM configurations.

- 8** Delete the **Efpga.upgrade_kit** file on the primary CMM by entering:

```
-> rm Efpga.upgrade_kit
```

Note. Use the **ls** command to confirm that the upgrade kit file has been deleted on the primary CMM.

- 9** If you have a secondary CMM enter the following on the primary CMM to delete the **Ffpga.upgrade_kit** file on the secondary CMM. Otherwise, proceed to [Step 10](#).

```
-> rrm /flash/Efpga.upgrade_kit
```

Note. Use the **rls** command by entering

```
-> rls /flash
```

to confirm that the upgrade kit file has been deleted on the secondary CMM.

- 10** Enter the following to restore the **Working** directory:

```
-> copy certified working
```

- 11** If you have a secondary CMM enter the following on the primary CMM to synchronize the images on the primary with those on the secondary CMM. Otherwise, proceed to [Step 12](#).

```
-> copy flash-synchro
```

- 12** Power cycle the switch or use the **reload all** command.

Note. If the image files are 5.1.6.R02, the MiniBoot and BootROM are 5.4.1.455.R01, and the FPGA is 44 the upgrade to 5.1.6.R02 is now complete. (See [Verifying the Upgrade with the CLI on page 37](#) for more information.)

Verifying the Upgrade with the CLI

You can use Command Line Interface (CLI) commands to verify that your upgrade is successful. To verify that the CMM's firmware was correctly upgraded to FPGA 44 and to verify that the MiniBoot/BootROM has been successfully upgraded to 5.4.1.455.R01 on OmniSwitch 7700, 7800, and 8800 switches, use the **show hardware info** command as shown below:

```
-> show hardware info
CPU Type                : UltraSPARC IIe (SPARC-V9),
Flash Manufacturer      : AMD,
Flash size              : 33554432 bytes (32 MB),
RAM Manufacturer        : Micron,
RAM size                : 134217728 bytes (128 MB),
NVRAM Battery OK       : YES,
Interrupt Boot Jumper  : ON,
Force UART Defaults Jumper : ON,
Run Extended Memory Diags Jumper : OFF,
Spare Jumper           : OFF,
BootROM Version         : 5.4.1.455.R01
Backup Miniboot Version : 5.4.1.455.R01
Default Miniboot Version : 5.4.1.455.R01
FPGA (1) Version        : 44
FPGA (2) Version        : 44
```

The MiniBoot and BootROM have been correctly updated to 5.4.1.455.R01.

The firmware has been correctly updated to FPGA 44.

To verify that the software was correctly upgraded to 5.1.6.R02, use the **show microcode** command as shown below:

```
-> show microcode
Package      Release      Size      Description
-----+-----+-----+-----
Fadvrout.img 5.1.6.74.R02 983904 Alcatel Advanced Routing
Fbase.img    5.1.6.74.R02 4299687 Alcatel Base Software
Fdiag.img    5.1.6.74.R02 331338 Alcatel Diagnostics Archive
Feni.img     5.1.6.74.R02 1305860 Alcatel NI Software
Fl2eth.img   5.1.6.74.R02 985955 Alcatel Layer 2, Ethernet
Fos.img      5.1.6.74.R02 1495164 Alcatel Operating System
Fqos.img     5.1.6.74.R02 313006 Alcatel Quality of Service
Frout.img    5.1.6.74.R02 718511 Alcatel Routing
Fsecu.img    5.1.6.74.R02 130240 Alcatel Security
Fweb.img     5.1.6.74.R02 1433253 Alcatel Webview - Main
Fwebadvrout.img 5.1.6.74.R02 249619 Alcatel Webview - Advanced Routing
Fweb12eth.img 5.1.6.74.R02 311057 Alcatel Webview - Layer 2 and Ethern
Fwebqos.img  5.1.6.74.R02 261472 Alcatel Webview - Quality of Service
Fwebrount.img 5.1.6.74.R02 345730 Alcatel Webview - Routing
Fwebsecu.img 5.1.6.74.R02 210602 Alcatel Webview - Security
```

The image files have been correctly updated to 5.1.6.R02.

Note. Refer to the *OmniSwitch CLI Reference Guide* for complete documentation on CLI commands.

Troubleshooting

Program Enable Jumpers Not Installed

Recommendation. Review all steps in this procedure before beginning.

By default, a shunt connecting pins 1 and 2 on jumper block J31 (OS7700-CMM), jumper J345 (OS7800-CMM), or jumper J21 (OmniSwitch 8800) that allows the firmware upgrade to be performed is installed on all CMMs. (These jumpers are illustrated in “[CMM Jumper Locations](#)” on page 39.) Only perform these steps if this shunt has been removed.

- 1 When it will not have an adverse effect on the network, power off the switch.
- 2 Loosen the CMM’s two captive screws that secure the module to the chassis. If necessary, use a flat-blade screwdriver to loosen the screws. Be sure that both captive screws are completely disengaged from the threaded holes in the chassis before continuing
- 3 Simultaneously pull the two module extractor levers—one on top of the CMM and one on the bottom—until the CMM disengages from the chassis.
- 4 Holding the module in both hands, carefully slide it out of the chassis along the card guide. The module should slide out easily. Do not force the module from the slot.
- 5 Place the CMM on a clean, flat, static-free surface.
- 6 If you have an OmniSwitch 7700 CMM (OS7700-CMM), connect pins 1 and 2 on jumper block J31, which is near the lithium battery. If you have an OmniSwitch 7800 CMM (OS7800-CMM), connect pins 1 and 2 on jumper block J345, which is also near the lithium battery. If you have an OmniSwitch 8800 CMM (OS8800-CMM), connect pins 1 and 2 on jumper block J21, which is near the lithium battery.

Note. See “[CMM Jumper Locations](#)” on page 39 for more information.

- 7 Holding the CMM in both hands, carefully slide it into the chassis card guide. The CMM should slide in easily. Do not force the CMM into the slot. If any resistance is encountered, ensure the CMM is aligned properly in the card guide.
- 8 When the CMM is nearly seated in the slot, be sure that the two extractor levers—one on top of the CMM and one on the bottom—are slightly opened (approximately 30 degrees). This allows the notch on each extractor lever to grasp the rail on the chassis. Once the notches have grasped the rail, press both extractor levers inward simultaneously until the CMM is firmly seated.
- 9 Once the CMM is firmly seated, secure the CMM to the chassis by tightening the two captive screws. *Be sure not to overtighten the captive screws. If you use a screwdriver, the torque used to tighten the screws must not exceed 2.3 inch pounds.*

Note. Refer to the appropriate *OmniSwitch Hardware Users Guide* for additional documentation on adding and removing modules.

CMM Jumper Locations

This section provides diagrams FPGA enable jumper block locations of the OmniSwitch 7700 CMM (see [“OS7700-CMM” on page 39](#)), OmniSwitch 7800 CMM (see [“OS7800-CMM” on page 40](#)), and the OmniSwitch 8800 CMM (see [“OS8800-CMM” on page 41](#)).

OS7700-CMM

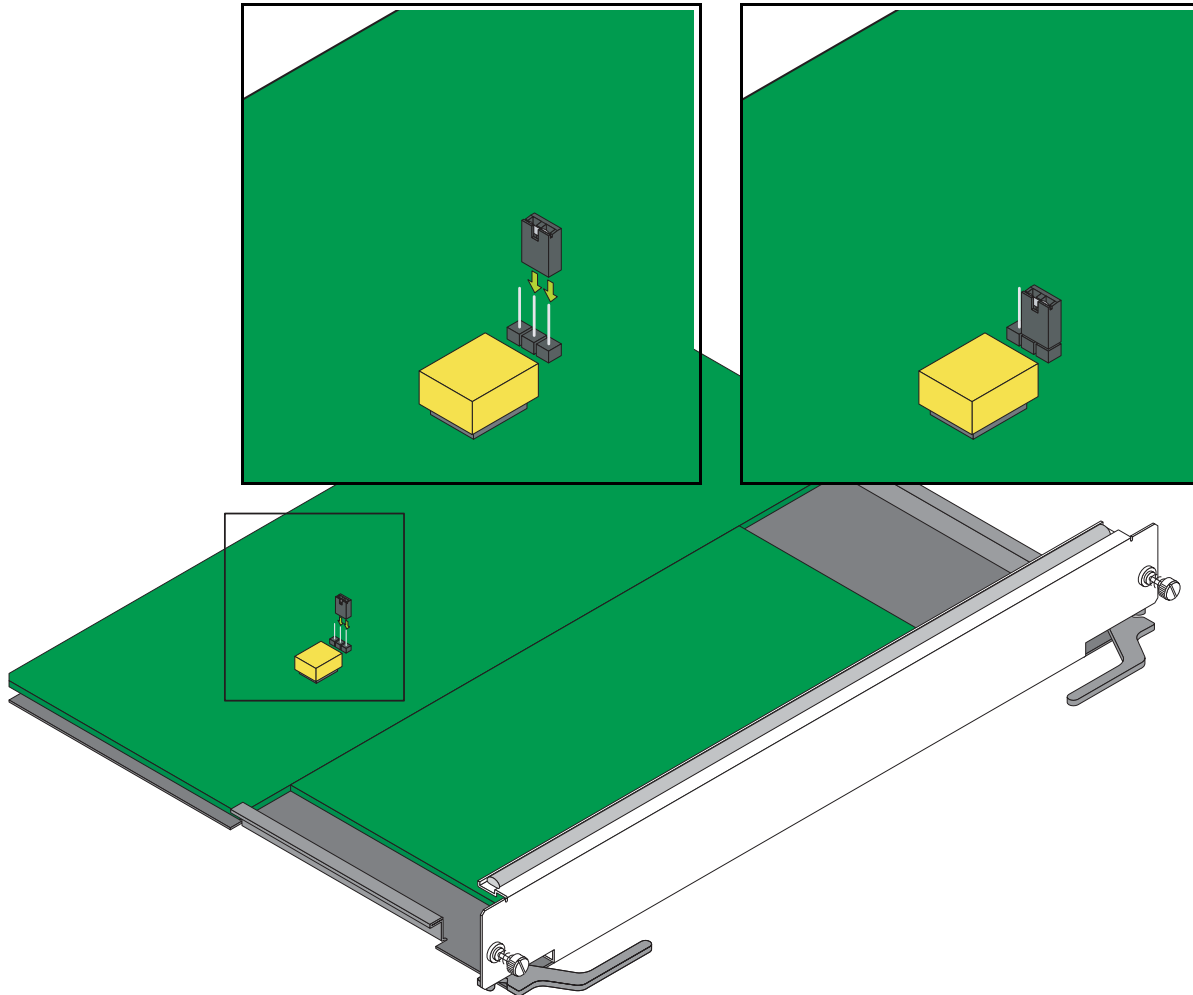

As shown in the figure above pins 1 and 2 must be connected on jumper block J31, which is located near the lithium battery, to ensure a successful FPGA upgrade. (Please note that pin 1 is located the closest to the front panel, pin 2 is in the middle, and pin 3 is located closest to the backplane connector.) If pins 1 and 2 are not connected as shown in the figure above then perform the steps described in [“Program Enable Jumpers Not Installed” on page 38](#) to perform an FPGA upgrade.

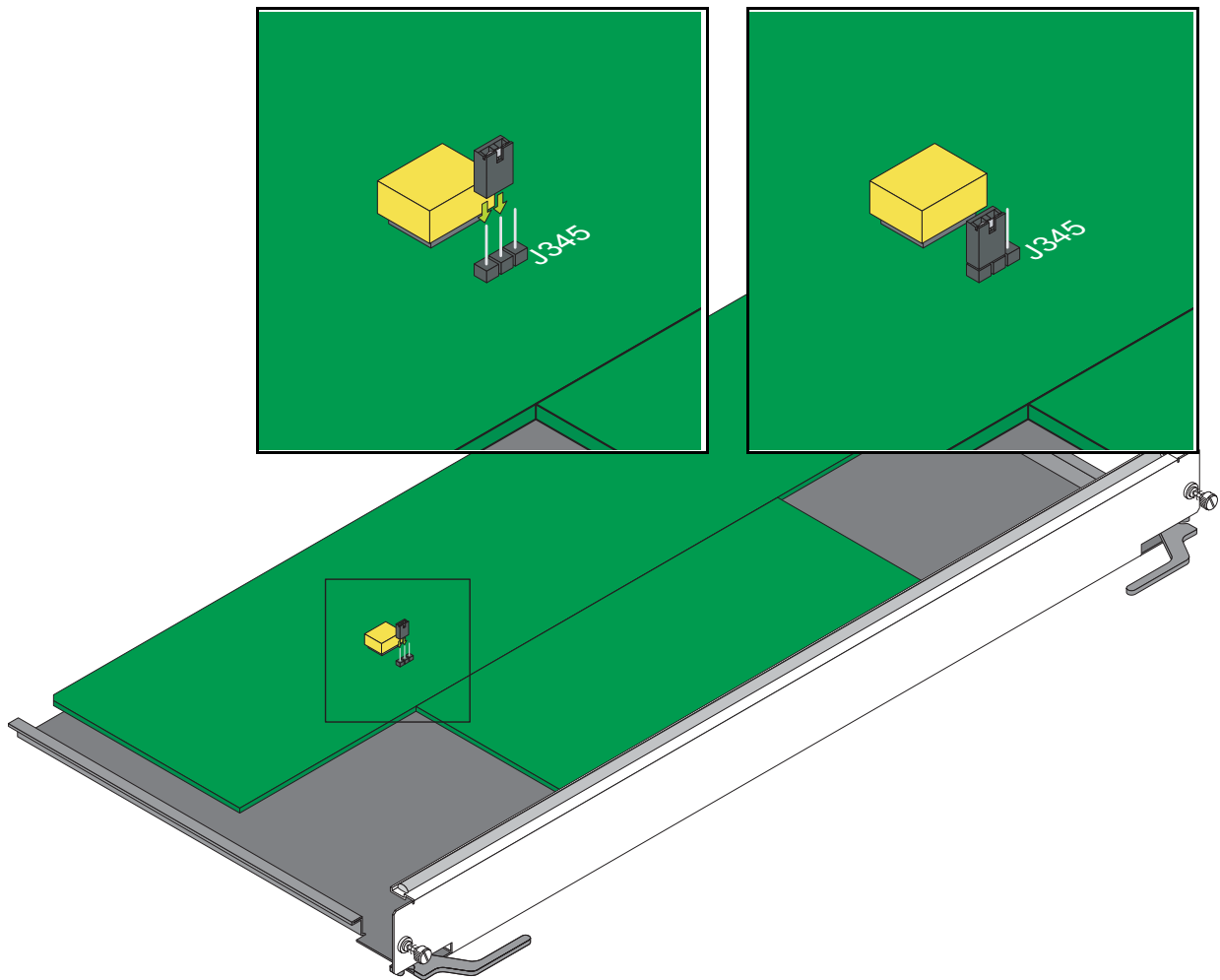
OS7800-CMM

As shown in the figure above pins 1 and 2 must be connected on jumper block J345, which is located near the lithium battery, to ensure a successful FPGA upgrade. (Please note that pin 1 is located the closest to the top edge of the CMM, pin 2 is in the middle, and pin 3 is located facing the bottom edge of the CMM.) If pins 1 and 2 are not connected as shown in the figure above then perform the steps described in [“Program Enable Jumpers Not Installed” on page 38](#) to perform an FPGA upgrade.

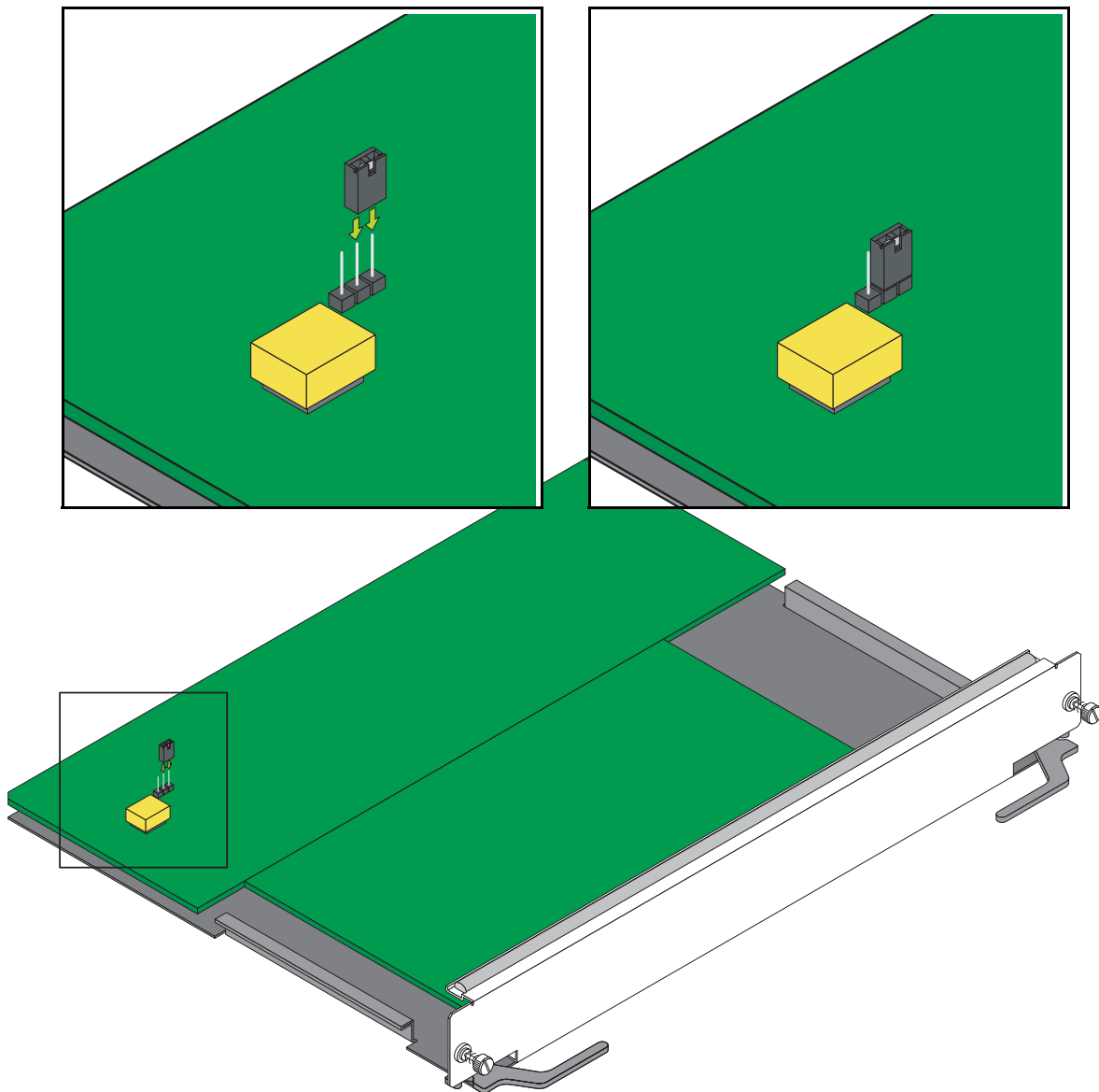
OS8800-CMM

As shown in the figure above pins 1 and 2 must be connected on jumper block J21, which is located near the lithium battery, to ensure a successful FPGA upgrade. (Please note that pin 1 is located facing the bottom edge of the CMM, pin 2 is in the middle, and pin 3 is located the closest to the top edge of the CMM.) If pins 1 and 2 are not connected as shown in the figure above then perform the steps described in [“Program Enable Jumpers Not Installed” on page 38](#) to perform an FPGA upgrade.

This page intentionally blank



Alcatel Internetworking
26801 West Agoura Road
Calabasas, CA 91301
(818) 880-3500 FAX (818) 880-3505

US Customer Support: (800) 995-2696
International Customer Support: (818) 878-4507
Internet: <http://eservice.ind.alcatel.com>